

GHA

CATALOGO LINEA **GHA** • **GHA** LINE CATALOGUE • KATALOG SERIE **GHA**



Industria chimico-farmaceutica
Pharmaceutical applications
Pharmaindustrie



Applicazioni in ambiente marino
Marine applications
Marineanwendungen



Industria alimentare
Food applications
Lebensmittelindustrie

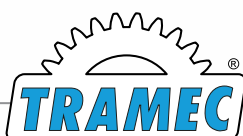



MADE IN ITALY

Per TRAMEC l'espressione "MADE IN ITALY" possiede un significato molto più profondo di quanto gli venga attribuito nell'uso comune. Tutti i prodotti di TRAMEC sono infatti il risultato di :

PROGETTAZIONE E CREATIVITA' ITALIANA

Ogni riduttore della gamma TRAMEC è completamente progettato in ITALIA, nella sede principale di CALDERARA DI RENO (BOLOGNA), nel cuore della cosiddetta "MOTOR VALLEY" e "PACKAGING VALLEY", un territorio dove la meccanica è da sempre protagonista. Qui gli ingegneri TRAMEC esprimono al meglio la creatività ITALIANA, avvalendosi di strumenti sempre più evoluti per progettare riduttori innovativi e personalizzabili in base a specifiche esigenze del cliente.

PRODUZIONE E MONTAGGIO

Tutti i componenti principali dei riduttori TRAMEC vengono realizzati dalla rete produttiva della nostra Azienda, che si avvale anche dell'esperienza e delle capacità di artigiani selezionati presenti sul medesimo territorio.

Dall'assemblaggio di tali componenti, eseguito con perizia dai nostri tecnici esperti, nascono i riduttori TRAMEC. Il risultato è un prodotto di altissima qualità, come quelli descritti nel catalogo che state sfogliando.

SERVIZIO AL CLIENTE

L'importanza che TRAMEC attribuisce ai propri clienti non si riflette solamente nel fornire un prodotto di elevata qualità, ma anche nel garantire un'assistenza PRE e POST-VENDITA all'altezza del prodotto fornito.

In questo modo, curando al massimo la qualità dei prodotti e rimanendo costantemente al fianco del Cliente, si esprime a pieno l'ITALIANITA' della nostra Azienda.

Ecco cosa significa per TRAMEC l'espressione "MADE IN ITALY".

At TRAMEC "MADE IN ITALY" is an expression with a much deeper meaning , as all TRAMEC products are the result of :

ITALIAN DESIGN & CREATIVITY

TRAMEC is headquartered in CALDERARA DI RENO, BOLOGNA, in the heart of Italy's famous " MOTOR VALLEY" or " PACKAGING VALLEY" where the art of performance is mastered with the science of precision.

Italian design & engineering creativity is allowed via the most advanced tools by TRAMEC engineers in the design of our standard and customized products.

PRODUCTION & ASSEMBLY

The designs of TRAMEC are brought to life through the careful hands of machinists and technicians expressing the local tradition of excellence. All major components are produced , assembled , and inspected within the TRAMEC manufacturing organization.

From this long tradition, expressing performance and precision into objects of exceptional quality , we introduce the TRAMEC'S GEARBOXES.

CUSTOMER CARE

From conception to delivery, we at TRAMEC are focused upon our customers. Our passion is to bring to you the highest performing precision power transmission products, with a never ending commitment to quality and value. From the selection of a new power transmission element, through delivery of the component, to support after the sale, we are aiming to excellence. What we want to convey always is that everything we do is Made in Italy so to assure a complete experience of Italian culture and values.

From everyone at TRAMEC, this is what it means to say "MADE IN ITALY".

Der Begriff "MADE IN ITALY" hat für TRAMEC eine besondere Bedeutung. Alle Produkte von TRAMEC sind das Ergebnis von:

ITALIENISCHER KREATIVITÄT UND PLANUNG

Alle Produkte werden komplett in ITALIEN entworfen. TRAMEC hat ihren Hauptsitz in CALDERARA DI RENO, BOLOGNA, im Herzen Italiens, mitten im MOTOR VALLEY oder PACKAGING VALLEY. Diese Region ist bekannt für ihre fortschrittlichen mechanischen Produkte.

Italienisches Design und Kreativität werden, unter Anwendung moderner Hilfsmittel, durch unsere Ingenieure umgesetzt und in die Planunneuer Produkte mit einbezogen. Das Ergebnis sind qualitativ hochstehende Produkte, die Sie in diesem Katalog finden.

PRODUKTION UND MONTAGE

Alle wichtigen Komponenten der Produkte von TRAMEC sind das Ergebnis des Produktionsnetzes unseres Unternehmens, das sich auf die Erfahrung und die Fähigkeiten der Handwerker in unserem Gebiet stützt. Durch den Zusammenbau dieser Komponenten, der vollkommen von den erfahrenen und ausgezeichneten Technikern von TRAMEC ausgeführt wird.

Aus dieser langen Tradition, die Leistung und Präzision in Objekte von außergewöhnlicher Qualität zum Ausdruck bringt, führen wir die TRAMEC-GETRIEBE ein.

KUNDENDIENST

Von der Planung bis zur Auslieferung steht bei TRAMEC der Kunde im Mittelpunkt. Wir liefern nicht nur qualitativ hochstehende Produkte, sondern beraten unsere Kunden vor und nach dem Kauf durch unseren KUNDENDIENST. Stetigkeit und Kundennähe sehen wir als höchste Priorität.

All das zusammen bedeutet für TRAMEC "MADE IN ITALY".



Cos'è il trattamento G.H.A.® (*)

G.H.A.® è la più recente ed innovativa tecnologia applicabile alle superfici di tutte le leghe a base alluminio. Consiste in uno speciale trattamento di ossidazione anodica, con spessore da 1 a 100µm, a cui segue una sigillatura delle microporosità mediante ioni d'argento (Ag+).

What is G.H.A.® (*)

The G.H.A.® is the most recent and innovative technology applicable to the surface of all aluminum -base alloys. It consists of a special anodic oxidation treatment, with thickness ranging from 1 to 100 µm, followed by the sealing of the micro porosities through silver ions (Ag+).

Was ist die G.H.A.® -Behandlung (*)

G.H.A.® ist die modernste, innovativste auf allen aus Aluminiumlegierungen bestehenden Oberflächen anwendbare Technologie. Sie besteht aus einer speziellen Behandlung durch anodische Oxidation mit einer Stärke von 1 bis zu 100µm, darauf folgt dann eine Versiegelung der Mikroporen durch Silberionen (Ag+). Die anodische Oxidation ist für Alumi-

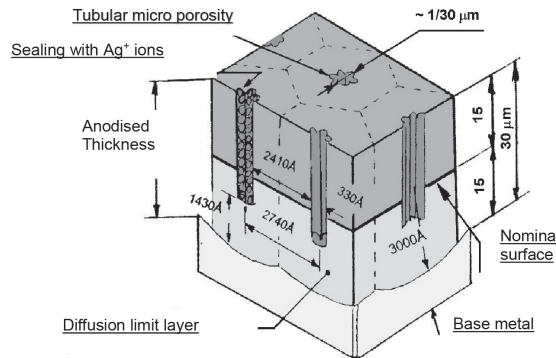

L'Ossidazione Anodica è per le leghe a base alluminio il trattamento protettivo più congeniale e sicuro fra tutti gli altri perché è inasportabile, infatti l'alluminio della base si trasforma, durante il processo galvanico, in ossido di alluminio (Al₂O₃), generando uno strato protettivo di tipo ceramico molto duro, refrattario al calore ed inasportabile. I cristalli dell'ossido di alluminio (Al₂O₃) hanno una struttura a nido d'ape con cristalli ottaedrici molto dura e compatta, con un foro capillare al centro degli ottaedri che penetra quasi fino alla base degli stessi.

The Anodic Oxidation of aluminum – base alloys is the most suitable and safe protection treatments because it's unremovable, in fact, during the galvanic process, the aluminum base is transformed into aluminum oxide (Al₂O₃), generating a very hard protective layer, similar to ceramic, which is heat resistant and not removable. Aluminum oxide crystals are disposed in a honeycomb structure, very hard and compact, with a capillary hole at the center of the octahedron and nearly reaching the base of them.

numlegierungen die geeignetste und sicherste Schutzbehandlung, da sie nicht entfernt werden kann. Das Aluminium wird nämlich während der Galvanisierung in Aluminiumoxid (Al₂O₃) verwandelt und erzeugt so eine sehr harte, keramikartige Schutzschicht, die wärmebeständig und nicht entfernbar ist. Die Aluminiumoxidkristalle (Al₂O₃) haben eine wabenförmige, sehr harte und kompakte Struktur mit achtfächigen Kristallen. In der Mitte der Oktaeder befindet sich eine feine Bohrung, die beinahe bis auf die Grundfläche derselben reicht.

Questi pori sono anche ricettacolo di sporco e di microorganismi tanto che le superfici anodizzate si macchiano. Per questa ragione vengono spesso ricoperte con sostanze coloranti che sigillano i pori (nero o altri colori). I ricercatori della società SOUKEN di Kyoto hanno studiato la possibilità di sigillare i pori dei cristalli degli ossidi anodici, mediante uno speciale processo galvanico impiegando ioni Ag⁺, trasformando così quello che era considerato un difetto, la porosità, in un pregio in quanto queste costituiscono piccoli serbatoi per gli ioni Ag⁺, risultando così uniformemente distribuiti sulla superficie e permanentemente presenti durante l'usura delle stesse.

These pores are also a receptacle for dirt and microorganisms so that the anodized surfaces easily get stained. For this reason they are often treated with coloring substances to seal the pores (with black or other colors). The researchers of the company SOUKEN of Kyoto studied the possibility of sealing the crystal pores of the anodic oxides by a special galvanic process using Silver ions Ag⁺, thereby transforming what was considered a defect (the porosity) into an advantage. In fact, these pores provide a proper reservoir for Ag⁺ ions, thus being uniformly distributed on the surface and permanently present during the wear of the oxide layer. The G.H.A.® process (Golden Hard Anodizing) was then patented (Patent No. EP1207220). The high hardness of anodic oxide, HV 500-600, combined with the extraordinary properties of silver ions, see Table 1, gives to the treated surface biotechnological characteristics of great practical interest, see Table 2, ranging from the pharmaceutical and food industry to the technical and scientific fields. Not to mention the high hardness and refractory heat factor that are typical of the anodic oxides.

In diesen Poren lagern sich auch Schmutz und Mikroorganismen ab, sodass die eloxierten Oberflächen fleckig werden. Aus diesem Grund werden sie oft mit Farbstoffen überdeckt, durch die die Poren geschlossen werden (in Schwarz oder auch in anderen Farben). Die Forscher der Firma SOUKEN aus Kyoto haben die Möglichkeit untersucht, die Poren der Kristalle der anodischen Oxide mit einem speziellen Galvanisierungsverfahren zu versiegeln, bei dem Silberionen verwendet werden, sodass das, was bisher als Defekt betrachtet wurde, nämlich die Poren, nun zu einem Vorteil wird, da diese winzigen Vertiefungen zu Aufnahmeflächen für die Silberionen werden und so auf der gesamten Oberfläche gleichmäßig verteilt und während ihres Verschleißes ständig vorhanden sind. Der G.H.A.®-Prozess (Golden Hard Anodizing) wurde patentiert (Patent Nr. EP1207220). Die außerordentliche Härte des anodischen Oxids, HV 500-600, verleiht der behandelten Oberfläche zusammen mit den exzellenten Merkmalen der Silberionen, siehe Tabelle 1, biotechnologische Merkmale, die für die Anwendungen sehr interessant sind, siehe Tabelle 2, und von der Pharmaindustrie bis hin zu technischen und wissenschaftlichen Sektoren gehen. Ferner darf nicht vergessen werden, dass die außerordentliche Härte und die Hitzebeständigkeit weitere Merkmale der anodischen Oxide darstellen.

Tab. 1

PROPRIETÀ TRATTAMENTO G.H.A.®	PROPERTY OF G.H.A.® TREATMENT	MERKMALE DER G.H.A.®-BEHANDLUNG
Elevata capacità antibatterica ed antimuffa (Battericida)	<i>High antibacterial capacity and anti-mold (Antibacterial)</i>	Hohe antibakterielle und gegen Schimmelbildung wirkende Leistungsfähigkeit (Bakterizid)
Resistenza alla corrosione	<i>Corrosion resistance</i>	Korrosionsbeständig
Basso coefficiente d'attrito, autolubrificazione e resistenza all'usura.	<i>Low coefficient of friction, self-lubrication and wear resistance.</i>	Niedriger Reibungskoeffizient, selbstschmierend und Verschleißbeständig.
Elevata capacità antistatica	<i>High antistatic capacity</i>	Beträchtliche antistatische Leistungen
Capacità di assorbire calore e di dissiparlo con onde infrarosse	<i>Ability to absorb heat and dissipate it as ultra-infrared waves</i>	Fähigkeit zur Aufnahme von Wärme und deren erneute Ausgabe über Infrarotstrahlen
Elevata conducibilità termica ed alto rendimento termodinamico	<i>High thermal conductivity and high thermodynamic efficiency</i>	Hohe Wärmeleitfähigkeit und hoher thermodynamischer Wirkungsgrad

CARATTERISTICHE BIOTECNOLOGICHE (*) BIOTECHNOLOGY FEATURES (*) BIOTECHNOLOGISCHE MERKMALE (*)						
Materiale Material Material	Durezza HV Hardness HV HV - Härte	Temperatura di Fusione Melting temperature Schmelztemperatur	Coefficiente di attrito Coefficient of friction Reibungskoeffizient	Capacità Batteriostatica Bacteriostatic capacity Bakteriostatische Fähigkeit	Resistenza alla corrosione SST Corrosion resistance SST Korrosionsbeständigkeit SST	Resistenza all'usura Resistance to consumption Verschleißbeständigkeit
Lega di Alluminio Aluminum Alloy Aluminumlegierung	70÷100	680°C	0,44	nessuna none Keine	100 h	1000 h
Ossido di Alluminio con trattamento G.H.A.® Aluminum oxide with G.H.A.® treatment Mit dem G.H.A.® Verfahren behandeltes Aluminiumoxid	500÷550	2100°C	0,025	elevatissima high sehr hoch	10.000 h	1.000.000 h
Ossidazione dura Hard oxidizing harte Oxidation	500÷550	2100°C	0,15	nessuna none Keine	200 ÷ 500 h	1.000 h

Pertanto il coating G.H.A. in combinazione di una appropriata lega leggera (nel nostro caso l'alluminio) può essere considerato, da parte dei progettisti, un vero e proprio nuovo materiale e può rappresentare una valida alternativa sia a materiali costosi come leghe di Titanio o acciai inox o ad acciai rivestiti di coating blasonati e costosi come TIN – PVD – CVD – Cromo duro – Nichel chimico – Nichel-Teflon etc.

Therefore the G.H.A. coating, if combined with the appropriate aluminum alloy, can be considered by the designers as a real new material and can be a good alternative to expensive metals such as titanium alloys, stainless steel or steel treated by expensive and well known coatings like TIN – PVD – CVD – Hard chromium – Chemical Nickel – Nickel - Teflon etc.

Daher kann die G.H.A.-Beschichtung zusammen mit einer geeigneten Leichtlegierung (in unserem Fall Aluminum) von den Planern eigentlich als ein neues Material betrachtet werden, und kann sowohl für teure Materialien wie Titanlegierungen oder Edelstahl als auch für Stahl mit teuren und edlen Beschichtungen wie TIN – PVD – CVD – Hartchrom – chemisches Nickel – Nickel-Teflon usw. eine wertvolle Alternative darstellen.

(*): Tratto dal documento "Valutazione Effetto Battericida su Trattamento G.H.A. (a cura del centro servizi analisi e prove di G.H.A. Europe)"

(*): Taken from the document "Valutazione Effetto Battericida su Trattamento G.H.A. (a cura del centro servizi analisi e prove di G.H.A. Europe)"

(*)Auszug aus dem Dokument "Auswertung der bakterientötenden Auswirkung bei G.H.A.-Behandlung (verfasst vom Zentrum für Analysen und Tests von G.H.A Europe)"

Tra le numerose proprietà vantate dal trattamento G.H.A. spiccano quelle antibatteriche ed anticorrosive che rendono il trattamento particolarmente adatto alle applicazioni in ambienti aggressivi o in cui sia richiesto un alto livello di sicurezza contro possibili contaminazioni batteriche.

Proprietà antibatteriche

La norma tecnica internazionale ISO 22196:2011, che a sua volta si basa sulla procedura JIS Z 2801:2010, pone delle linee guida sui metodi di analisi, materiali e criteri di valutazione dell'attività antibatterica, costituendo un criterio univoco ed uno standard per le analisi.

In accordo alla ISO 22196:2011, si è decretata l'efficacia battericida del trattamento G.H.A..

L'alluminio trattato G.H.A. ha sfavorito la crescita microbiologica di almeno 1000 volte rispetto allo stesso alluminio non trattato G.H.A..

Resistenza alla corrosione

• **Conformemente alla UNI EN ISO 9227:2017** sono state effettuate prove di corrosione in camera a nebbia salina neutra (NSS) che hanno fornito risultati positivi, misurando una durata superiore a 2016 ore di esposizione, nel caso di trattamento G.H.A. abbinato ad una specifica lega di alluminio.

• **Secondo la ISO 4628-1:2003 e mediante analisi spettrofotometrica** sono stati condotti test atti a valutare l'intensità del cambiamento delle superfici di alluminio trattato G.H.A. a contatto con soluzioni di detergenti e/o disinfettanti o sanificanti professionali, fornendo informazioni sulla compatibilità e controindicazioni in base al principio attivo.

Oltre ai test effettuati dalla società G.H.A. Europe S.r.L., TRAMEC ha condotto numerose prove presso laboratori indipendenti ed accreditati, avvalendosi della consulenza di società di ricerca specializzate. Gli enti coinvolti sono stati i seguenti:

- **Cepra Srl** - Via del Tintoretto 6/2 - 40033 Casalecchio di Reno (BO) – Italy - C.F. e P.IVA 02002271209 - accreditato ACCREDIA n. 1679L - CERTIFICATA ISO 9001 e ISO/IEC 17025:2005
- **Tecnal Srl** - Via Castelfranco 17/D – Loc. Bazzano 40053 Valsamoggia (BO) - C.F. 02460570373 – P.IVA 00579881202 - accreditato ACCREDIA n. 0299 - conforme alla norma UNI CEI EN ISO/IEC 17025:2005
- **Gelt International Srl** - Via A. Costa 228 - 40134 Bologna - P. Ival/ CF 03650351202

Among the many advantages of the G.H.A. treatment, there are the antibacterial and anticorrosive properties that make the treatment particularly suitable for applications in harsh environments or where a high level of safety is required against possible bacterial contamination.

Antibacterial properties

The international technical standard ISO 22196:2011, which in turn is based on the JIS Z 2801:2010 procedure, sets guidelines on the analysis methods, materials and evaluation criteria for antibacterial activity, constituting a univocal criterion and a standard for analysis.

The bactericidal efficacy of the G.H.A. treatment was declared in accordance with ISO 22196: 2011.

Aluminium treated with G.H.A. has discouraged microbiological growth by at least 1000 times compared to the same aluminium not treated with G.H.A..

Corrosion resistance

• **In compliance with UNI EN ISO 9227:2017**, corrosion tests were carried out in a neutral salt spray (NSS) chamber which gave positive results, measuring over 2016 hours of exposure, in the case of G.H.A. combined with a specific aluminium alloy.

• **According to ISO 4628-1:2003 and by means of spectrophotometric analysis**, tests have been conducted to assess the intensity of the change of aluminium surfaces treated with G.H.A. in contact with detergent and/or disinfectant or professional sanitising solutions, providing information on compatibility and contraindications based on the active ingredient.

In addition to the tests carried out by G.H.A. Europe S.r.L., TRAMEC has conducted numerous tests at independent and accredited laboratories, working with specialised research companies. The bodies involved were the following:

- **Cepra Srl** - Via del Tintoretto 6/2 - 40033 Casalecchio di Reno (BO) – Italy - Tax Code and VAT no. 02002271209 - ACCREDIA accreditation no. 1679L - ISO 9001 and ISO/IEC 17025:2005 CERTIFIED
- **Tecnal Srl** - Via Castelfranco 17/D - Loc. Bazzano 40053 Valsamoggia (BO) - Tax Code 02460570373 - VAT no. 00579881202 - ACCREDIA accreditation no. 0299 - in compliance with standard UNI CEI EN ISO/IEC 17025:2005
- **Gelt International Srl** - Via A. Costa 228 - 40134 Bologna - VAT no./ Tax Code 03650351202

Unterden zahlreichen Merkmalen der G.H.A.-Behandlung stechen die antibakteriellen und antikorrosiven Eigenschaften hervor, dank der die Behandlung besonders für Anwendungen in aggressiven Umgebungen geeignet ist bzw. wenn ein hohes Maß an Sicherheit gegen mögliche bakterielle Kontaminationen erforderlich ist.

Antibakterielle Eigenschaften

Die internationale technische Norm ISO 22196:2011, die wiederum auf dem Verfahren JIS Z 2801:2010 basiert, legt die Richtlinien für Analysemethoden, Materialien und Kriterien zur Beurteilung der antibakteriellen Aktivität fest und stellt ein eindeutiges Kriterium und eine Norm für die Analysen dar.

Gemäß ISO 22196:2011, wurde die bakterizide Wirksamkeit der G.H.A.-Behandlung festgestellt.

Mit G.H.A. behandeltes Aluminium weist gegenüber dem gleichen, nicht mit G.H.A. behandeltem Aluminium ein mindestens 1000-mal geringeres mikrobiologisches Wachstum auf.

Korrosionsbeständigkeit

• **Gemäß UNI EN ISO 9227:2017** wurden Korrosionstests in einer neutralen Salzsprühkammer (NSS) durchgeführt, die, für die G.H.A.-Behandlung in Kombination mit einer bestimmten Aluminiumlegierung nach einer **Expositionszeit von über 2016 Stunden positive Ergebnisse** lieferte.

• **Gemäß ISO 4628-1:2003 und mittels spektrophotometrische Analyse** wurden Tests durchgeführt, um die Intensität der Veränderung der mit G.H.A. behandelten Aluminiumoberflächen in Kontakt mit professionellen Reinigungs- und/oder Desinfektionsmittellösungen zu beurteilen und Informationen über Verträglichkeit und Gegenanzeigen auf Grundlage des Wirkstoffs zu liefern.

Zusätzlich zu den von dem Unternehmen G.H.A. Europe S.r.L. durchgeführten Tests hat TRAMEC mit Unterstützung von spezialisierten Forschungsunternehmen zahlreiche Tests in unabhängigen und akkreditierten Labors durchgeführt. Folgende Stellen waren beteiligt:

- **Cepra Srl** - Via del Tintoretto 6/2 - 40033 Casalecchio di Reno (BO) - Italien - Steuer-Nr. und MwSt.-Nr. 02002271209 - ACCREDIA - Akkreditierung Nr. 1679L - nach ISO 9001 und ISO/IEC 17025:2005 ZERTIFIZIERT
- **Tecnal Srl** - Via Castelfranco 17/D - Loc. Bazzano 40053 Valsamoggia (BO) - Steuer-Nr. 02460570373 - MwSt.-Nr. 00579881202 - ACCREDIA - Akkreditierung Nr. 0299 - konform mit UNI CEI EN ISO/IEC 17025:2005
- **Gelt International Srl** - Via A. Costa 228 - 40134 Bologna - MwSt.-Nr./ Steuer-Nr. 03650351202



• **Kiwa Cermet Italia S.p.A.** -
Via Cadriano, 23 - 40057 - Granarolo
dell'Emilia (BO) - P.IVA. 00627711203
- C.F. 03502820370 - Codice SDI:
SN4CSRI - accreditato ACCREDIA n.
0001 - conforme alla norma UNI CEI EN
ISO/IEC 17025:2005

• **Kiwa Cermet Italia S.p.A.** -
Via Cadriano, 23 - 40057 - Granarolo
dell'Emilia (BO) - VAT no. 00627711203
- Tax Code 03502820370 - SDI Code:
SN4CSRI - ACCREDIA accreditation no.
0001 - in compliance with standard UNI
CEI EN ISO/IEC 17025:2005

• **Kiwa Cermet Italia S.p.A.** -
Via Cadriano, 23 - 40057 - Granarolo
dell'Emilia (BO) - MwSt.-Nr. 00627711203
- Steuer-Nr. 03502820370 - SD-Code:
SN4CSRI - ACCREDIA-Akkreditierung
Nr. 0001 - konform mit UNI CEI EN ISO/
IEC 17025:2005

I test eseguiti da G.H.A. Europe S.r.L.
sono stati effettuati dal Laboratorio:

• **3A Laboratori srl** - Via A. Volta,
1/d 35020 Maserà di Padova (PD) -
ITALY
C.F. e P.IVA 04296730288 Registro
imprese di Padova - R.E.A. n 378402/PD
Accreditamento ACCREDIA n. 1165,
conformità UNI CEI EN ISO/IEC 17025:2005

*The tests conducted by G.H.A. Europe
S.r.L. were performed by the following
Laboratory:*

• **3A Laboratori srl** - Via A. Volta,
1/d 35020 Maserà di Padova (PD) - ITALY
Tax Code and VAT no. 04296730288
Padova Business Register - R.E.A. no.
378402/PD ACCREDIA accreditation no.
1165, in compliance with UNI CEI EN
ISO/IEC 17025:2005

Die von G.H.A. Europe S.r.L.
durchgeführten Tests wurden von
folgendem Labor durchgeführt:

• **3A Laboratori srl** - Via A. Volta,
1/d 35020 Maserà di Padova (PD) -
ITALIEN
Steuer-Nr. und MwSt.-Nr. 04296730288
Handelsregister Padua - Wirtschafts-
und Verwaltungsregister Nr. 378402/
PD ACCREDIA-Akkreditierung Nr.
1165, Konformität UNI CEI EN ISO/IEC
17025:2005

Brevetto TRAMEC

“RIDUTTORE MECCANICO TRATTATO CON IONI DI ARGENTO”

TRAMEC ha depositato un proprio
brevetto (brevetto N. EP18183494.6),
per proteggere la proprietà intellettuale
legata al riduttore denominato “GHA”.
L'uso dell'argento e/o degli ioni di
argento applicato ad un riduttore in
qualsiasi forma è protetto legalmente
dalle leggi vigenti e TRAMEC ne
possiede totalmente i diritti.

Tali diritti saranno, se necessario, fatti
rivalere da TRAMEC nelle sedi e nei
luoghi previsti.

Il deposito del brevetto d'invenzione è
stato curato da :
BUGNION S.p.A. -
Intellectual Property
Dipartimento Brevetti -
Ufficio di Bologna
Via di Corticella, 87 - Bologna (BO) ITALY

Patent TRAMEC

“MECHANICAL GEARBOX TREATED WITH SILVER IONS”

*TRAMEC deposited its own patent
(patent N. EP18183494.6) to protect the
intellectual property connected with
the gearbox named “GHA”.*

*The use of silver and / or silver ions
applied to a gearbox in any form is le-
gally protected by the laws in force .
All rights reserved by TRAMEC.*

*TRAMEC will make use of these rights,
if necessary, in the venues and places
provided by law.*

The patent filing has been cared for by :
BUGNION S.p.A. -
Intellectual Property
Patent Department -
Office of Bologna
Via di Corticella, 87 - Bologna (BO)
ITALY

Patent TRAMEC

“MECHANISCHES, MIT SILBERIONEN BEHANDELTES GETRIEBE”

TRAMEC hat ein Patent angemeldet
(Patent N. EP18183494.6), um das
geistige Eigentum im Zusammenhang
mit dem Getriebe mit der Bezeichnung
„GHA“ zu schützen.

*Der gebrauch von Silber und/oder Sil-
berionen, die an einem Getriebe mit
beliebiger Form angewendet werden,
ist durch die geltende Gesetzgebung
geschützt, und TRAMEC ist alleiniger
Besitzer aller diesbezüglichen Rechte.*

Diese Rechte werden von TRAMEC bei
Bedarf an den vorgesehenen Stellen
von TRAMEC geltend gemacht.

Die Anmeldung des Patents für die Erfin-
dung wurde durch folgende Firma ausge-
führt:
BUGNION S.p.A. -
Intellectual Property
Abteilung Patente -
Büros von Bologna
Via di Corticella, 87 - Bologna (BO) ITALY

1.0	GENERALITA'	GENERAL INFORMATION	ALLGEMEINES	8
1.1	Unità di misura	<i>Measurement units</i>	Maßeinheiten	12
1.2	Fattore di servizio	<i>Service factor</i>	Betriebsfaktor	12
1.3	Selezione	<i>Selection</i>	Wahl	14
1.4	Carichi radiali e assiali	<i>Radial and axial loads</i>	Radial- und Axialbelastungen	15
1.5	Potenza termica	<i>Thermal power</i>	Thermische Leistung	16
1.6	Lubrificazione	<i>Lubrication</i>	Ölschmierung	17
1.7	Installazione	<i>Installation</i>	Einbau	17
1.8	Rodaggio	<i>Running-in</i>	Einfahren	18
1.9	Manutenzione	<i>Maintenance</i>	Wartung	18
1.10	Operazioni di lavaggio	<i>Washing operations</i>	Reinigungsverfahren	19

GHA - PREMIUM

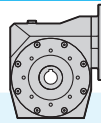

2.0	RIDUTTORI A VITE SENZA FINE GHA	GHA WORM GEARBOXES	SCHNECKENGETRIEBE GHA	21
-----	---------------------------------	--------------------	-----------------------	----

GHA - CLASSIC

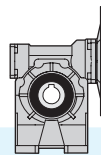

3.0	RIDUTTORI A VITE SENZA FINE GK	GK WORM GEARBOXES	SCHNECKENGETRIEBE GK	39
-----	--------------------------------	-------------------	----------------------	----

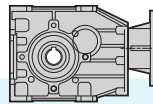

4.0	RIDUTTORI AD ASSI ORTOGONALI GT	BEVEL HELICAL GEARBOX GT	KEGELSTIRNRADGETRIEBE GT	59
-----	---------------------------------	--------------------------	--------------------------	----

GHA - MODULAR

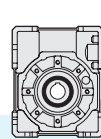

5.0	RIDUTTORI A VITE SENZA FINE GX	GX WORM GEARBOXES	SCHNECKENGETRIEBE GX	77
-----	--------------------------------	-------------------	----------------------	----



6.0	MOTORI MHA PREMIUM	MHA PREMIUM MOTORS	ENGINES MHA PREMIUM	97
-----	--------------------	--------------------	---------------------	----

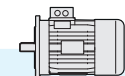

7.0	MOTORI GHA CLASSIC	GHA CLASSIC MOTORS	ENGINES GHA CLASSIC	101
-----	--------------------	--------------------	---------------------	-----

8.0	CONDIZIONI GENERALI DI VENDITA	TERM AND CONDITIONS OF SALE	ALLGEMEINE VERKAUFSBEDINGUNGEN	105
-----	--------------------------------	-----------------------------	--------------------------------	-----

GHA - PREMIUM

Riduttori a vite senza fine con carcassa in lega di alluminio opportunamente selezionata tale da instaurare uno strato spesso di trattamento G.H.A., disponibili dalla grandezza 30 alla 75.

I riduttori della serie PREMIUM presentano eccellenti proprietà antibatteriche e di resistenza alla corrosione (durata superiore a 2016 ore di esposizione in camera a nebbia salina neutra NSS) garantite dall'elevato spessore del trattamento G.H.A..

Lo speciale profilo esterno liscio della carcassa minimizza il deposito di sporcizia, permette la massima pulizia ed agevola le operazioni di risciacquo, grazie alla geometria dei coperchi che si estendono fino a pochi decimi di mm dall'albero cavo, proteggendo in questo modo le tenute.

Testato in laboratorio al fine di verificare la compatibilità e controindicazioni in base a diversi principi attivi delle soluzioni di detersivi e/o disinfettanti o sanificanti professionali. Per maggiori informazioni consultare la sezione dedicata alle operazioni di igienizzazione.

In virtù delle loro caratteristiche uniche, i riduttori della serie PREMIUM costituiscono la soluzione ideale per un'ampia gamma di applicazioni, in ambienti sensibili nei settori ALIMENTARE, FARMACEUTICO e MARINO.

Worm gearboxes with aluminum alloy casing subjected to enhanced GHA treatment, available from size 30 to 75.

PREMIUM series gearboxes have excellent antibacterial and corrosion resistance properties (over 2016 hours in NSS salt spray tests) guaranteed by the high thickness of the G.H.A. .. treatment.

Furthermore, the special smooth external profile of the gearbox body has been specially designed to allow for maximum cleanliness, having lab-tested the resistance to standard detergents (see the product cleaning section).

Tested in the laboratory in order to verify the compatibility and contraindications on the basis of several active ingredients of detergents and/or disinfectants or professional sanitising solutions. For further information, please refer to the section dedicated to sanitation operations.

Thanks to their unique characteristics, the PREMIUM series gearboxes are the ideal solution for a wide range of applications in sensitive environments in the FOOD, PHARMACEUTICAL and MARINE sectors.

Schneckengetriebe in einem Aluminiumgehäuse, das mit verstärktem GHA-Verfahren behandelt wurde, erhältlich in den Größen von 30 bis 75.

Die Getriebe der Serie PREMIUM haben ausgezeichnete antibakterielle und Korrosionsbeständigkeitseigenschaften (mehr als 2016 Stunden beim Test in salzhaltigem Sand NSS) Garantiert durch die hohe Dicke der G.H.A.-Behandlung

Das spezielle, glatte Außenprofil des Getriebekörpers wurde eigens dafür entwickelt, um die bestmögliche Reinigung zu gewährleisten, hierfür wurde in den Labors die Beständigkeit gegenüber Standard-Reinigungsmitteln getestet (siehe Abschnitt Reinigung des Produkts).

Im Labor getestet, um die Verträglichkeit und die Gegenanzeigen auf der Grundlage verschiedener Wirkstoffe von professionellen Reinigungs- und/oder Desinfektionsmittellösungen zu überprüfen. Für weitere Informationen wird auf den Abschnitt über die Desinfektionsverfahren verwiesen.

Dank ihren einzigartigen Merkmalen stellen die Getriebe der Serie PREMIUM die ideale Lösung für eine große Anzahl von Anwendungen in empfindlichen Bereichen in der LEBENSMITTEL-, PHARMA- UND SCHIFFFAHRTSBRANCHE dar.

GHA - PREMIUM

CERTIFICATO DI CONFORMITÀ AI REQUISITI DELLA DIRETTIVA 2006/42/CE ALLEGATO I CAP. 2.1

L'ente KIWA CERMET ITALIA S.p.A. ha condotto le attività di ispezione secondo la norma ISO/IEC 17020 certificando che i "Riduttori per macchine alimentari in alluminio con trattamento agli ioni di argento GHA (tipologia: GHA 30-40-50-63-75) sono conformi alla Direttiva 2006/42/CE, Allegato I capitolo 2.1 – Macchine alimentari e macchine per prodotti cosmetici o farmaceutici."

CERTIFICATO HACCP INTERNATIONAL IN AUSTRALASIA

HACCP International è un rinomato ente di certificazione, specializzato nella certificazione di attrezzature, prodotti e servizi utilizzati nell'industria alimentare (Metodologia HACCP).

Tonson Australia, nostro distributore in Australasia, ha ottenuto, con riferimento al proprio territorio, il certificato HACCP International per i riduttori GHA PREMIUM. I riduttori GHA PREMIUM sono certificati (in Australasia) come idonei per l'uso in impianti di produzione e di manipolazione degli alimenti che operano secondo un programma di sicurezza alimentare basato sugli standards HACCP.

Nonostante i riduttori delle serie Premium siano certificati come dispositivi idonei per l'utilizzo su macchine alimentari e dunque per applicazioni che operano in impianti di produzione e di manipolazione degli alimenti, **essi non sono certificati per l'utilizzo a contatto con gli alimenti.**

CERTIFICATE OF COMPLIANCE WITH THE REQUIREMENTS OF DIRECTIVE 2006/42/EC ANNEX I CHAP. 2.1

KIWA CERMET ITALIA S.p.A. carried out the inspection activities in accordance with standard ISO/IEC 17020, certifying that the "Food processing machinery reducers made of aluminium with GHA silver ion treatment (type: GHA 30-40-50-63-75) comply with Directive 2006/42/EC, Annex I chapter 2.1 - Foodstuffs machinery and machinery for cosmetics or pharmaceutical products"

HACCP INTERNATIONAL CERTIFICATE IN AUSTRALASIA

HACCP International is a renowned certification body, specialised in the certification of equipment, products and services used in the food industry (HACCP Methodology).

Tonson Australia, our distributor in Australasia, has obtained, for its reference area, the HACCP International certificate for GHA PREMIUM reducers. GHA PREMIUM reducers are certified (in Australasia) as suitable for use in food production and handling plants operating according to a food safety programme based on HACCP standards.

Although the Premium series reducers are certified as suitable devices for use on food processing machines and therefore for applications that operate in food production and handling plants, **they are not certified for use in contact with food.**

BESCHEINIGUNG DER KONFORMITÄT MIT DEN ANFORDERUNGEN DER RICHTLINIE 2006/42/EG, ANHANG I, KAP. 2.1

KIWA CERMET ITALIA S.p.A. hat seine Prüftätigkeiten gemäß ISO/IEC 17020 durchgeführt und bescheinigt, dass die „Getriebe für Lebensmittelmaschinen aus Aluminium mit GHA-Silberionenbehandlung (Typ: GHA 30-40-50-63-75) der Richtlinie 2006/42/EG, Anhang I Kapitel 2.1 - Lebensmittelmaschinen und Maschinen für kosmetische oder pharmazeutische Produkte“ entsprechen.

INTERNATIONALES HACCP-ZERTIFIKAT IN AUSTRALASIEN

HACCP International ist eine renommierte Zertifizierungsstelle, die sich auf die Zertifizierung von Geräten, Produkten und Dienstleistungen für die Lebensmittelindustrie spezialisiert hat (HACCP-Methodik).

Tonson Australia, unser Vertriebspartner in Australasien, hat mit Bezug auf sein Gebiet das Internationale HACCP-Zertifikat für die Getriebe GHA PREMIUM erhalten. Die Getriebe GHA PREMIUM sind (in Australasien) als geeignet für den Einsatz in Anlagen zur Produktion und Handhabung von Lebensmitteln, die im Rahmen eines Sicherheitsprogramms für Lebensmittel auf der Grundlage von HACCP-Normen betrieben werden, **zertifiziert.**

Obwohl die Getriebe der Baureihe Premium als Geräte zertifiziert sind, die für den Einsatz in Lebensmittelmaschinen und damit für Anwendungen in Anlagen zur Produktion und Handhabung von Lebensmitteln geeignet sind, **sind sie nicht für den Einsatz in Kontakt mit Lebensmitteln zugelassen.**

GHA



GHA - CLASSIC

Fanno parte di questo gruppo i riduttori a vite senza fine serie GK, disponibili dalla grandezza 30 alla 89, ed i riduttori ad assi ortogonali serie GT, disponibili dalla grandezza 56 alla 75.

Le carcasce hanno lo stesso profilo esterno dei riduttori TRAMEC standard (non GHA).

Dotati di carcassa in lega d'alluminio pressofuso su cui viene applicato il trattamento GHA standard, i riduttori della serie CLASSIC presentano le medesime proprietà antibatteriche della serie PREMIUM e resistenza alla corrosione standard (250 ore in test di nebbia salina NSS).

CERTIFICATO HACCP INTERNATIONAL IN AUSTRALASIA

Tonson Australia, nostro distributore in Australasia, ha ottenuto, con riferimento al proprio territorio, **il certificato HACCP International per i riduttori GHA CLASSIC.**

Le gamme di prodotti GKC e GTF sono certificate (in Australasia) come idonee per l'uso in impianti di produzione e di manipolazione degli alimenti che operano secondo un programma di sicurezza alimentare basato sugli standards HACCP.

In virtù delle loro caratteristiche uniche, i riduttori della serie GHA CLASSIC sono particolarmente idonei per le applicazioni in campo alimentare, farmaceutico e marino.

Nonostante i riduttori della serie CLASSIC siano certificati come dispositivi idonei per l'utilizzo su macchine alimentari e dunque per applicazioni che operano in impianti di produzione e di manipolazione degli alimenti, **essi non sono certificati per l'utilizzo a contatto con gli alimenti.**

This group includes GK series worm gearboxes, available from size 30 to 89, and the GT series bevel helical gearboxes, available from size 56 to 75.

The casings have the same external profile as the standard TRAMEC gearboxes (non-GHA) and are HACCP certified for food applications.

Fitted with a die cast aluminum alloy casing on which the standard GHA treatment is applied, the CLASSIC series gearboxes have the same very high antibacterial properties as the PREMIUM series and standard corrosion resistance (250 hours in NSS salt spray tests).

HACCP INTERNATIONAL CERTIFICATE IN AUSTRALASIA

Tonson Australia, our distributor in Australasia, has obtained, for its reference area, the HACCP International certificate for GHA CLASSIC reducers.

The GKC and GTF product ranges are certified (in Australasia) as suitable for use in food production and handling plants operating according to a food safety programme based on HACCP standards.

Thanks to their unique characteristics, the GHA CLASSIC series reducers are particularly suitable for applications in food, pharmaceutical and marine sectors.

Although the CLASSIC series reducers are certified as suitable devices for use on food processing machines and therefore for applications that operate in food production and handling plants, they are not certified for use in contact with food.

Zu dieser Gruppe gehören die Schneckengetriebe der Serie GK, die in den Größen von 30 bis 89 erhältlich sind, und die Kegelstirnradgetriebe der Serie GT, die in den Größen von 56 bis 75 erhältlich sind.

Die Gehäuse haben dasselbe Außenprofil wie die Standardgetriebe von TRAMEC (die nicht GHA-behandelten), und sie sind für Anwendungen im Lebensmittelbereich HACCP-zertifiziert.

Die mit einem Gehäuse aus der Standard-GHA-Behandlung unterzogenem Aluminiumdruckguss ausgestatteten Getriebe der Serie CLASSIC verfügen über dieselben bakterientötenden Merkmale wie diejenigen der Serie PREMIUM, und ihre Korrosionsbeständigkeit ist standardmäßig (250 Stunden beim Test mit salzhaltigem Nebel NSS).

INTERNATIONALES HACCP-ZERTIFIKAT IN AUSTRALASIEN

Tonson Australia, unser Vertriebspartner in Australasien, hat mit Bezug auf sein Gebiet **das Internationale HACCP-Zertifikat für die Getriebe GHA CLASSIC erhalten.**

Die Produktreihen GKC und GTF sind (in Australasien) als geeignet für den Einsatz in Anlagen zur Produktion und Handhabung von Lebensmitteln, die im Rahmen eines Sicherheitsprogramms für Lebensmittel auf der Grundlage von HACCP-Normen betrieben werden, zertifiziert.

Dank ihren einzigartigen Merkmalen sind die Getriebe der Serie GHA CLASSIC für Anwendungen in der Lebensmittel-, Pharma- und Schifffahrtsbranche besonders geeignet.

Obwohl die Getriebe der Baureihe CLASSIC als Geräte zertifiziert sind, die für den Einsatz in Lebensmittelmaschinen und damit für Anwendungen in Anlagen zur Produktion und Handhabung von Lebensmitteln geeignet sind, **sind sie nicht für den Einsatz in Kontakt mit Lebensmitteln zugelassen.**

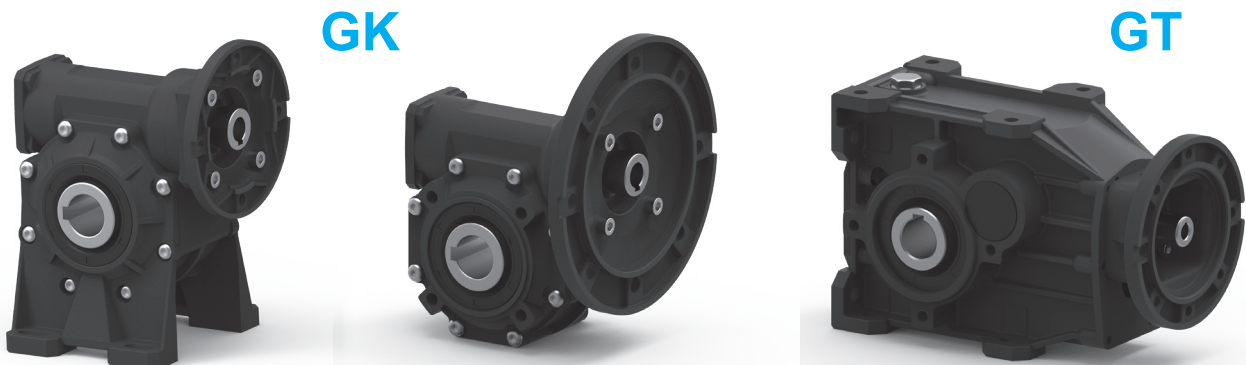

GHA - MODULAR

Riduttori a vite senza fine serie GX, disponibili dalla grandezza 30 alla 89.

Dotati di carcassa in lega d'alluminio pressofuso su cui viene applicato il trattamento G.H.A. standard, i riduttori della serie MODULAR presentano le stesse elevatissime proprietà antibatteriche della serie PREMIUM e resistenza alla corrosione standard (250 ore in test di nebbia salina NSS).

Il profilo esterno della carcassa è quello del riduttore standard (non GHA). Rispetto alle altre serie, la serie GHA MODULAR presenta maggiore versatilità grazie al corpo monolitico caratterizzato da una alta modularità di fissaggio per via delle lavorazioni in tolleranza di tutti i piani di appoggio. Per contro la carcassa risulta più difficile da pulire ed i riduttori di questa serie non sono certificati HACCP, ragion per cui se ne consiglia l'uso in ambienti alimentari secchi.

GX series worm gearboxes, available from size 30 to 89.

Fitted with a die cast aluminum alloy casing on which the standard G.H.A. treatment is applied, the MODULAR series gearboxes have the same very high antibacterial properties as the PREMIUM series and standard corrosion resistance (250 hours in NSS salt spray tests).

The external profile of the casing is that of the standard reducer (non-GHA). Compared to the other series, the GHA MODULAR series offers more versatility thanks to the monolithic body featuring high fastening modularity due to the machining tolerance of all support surfaces. On the other hand, the casing is more difficult to clean and the reducers of this series are not HACCP certified, which is why they are recommended for use in dry food environments.

Schneckengetriebe Serie GX, erhältlich in den Größen von 30 bis 89.

Die mit einem Gehäuse aus der Standard-G.H.A.-Behandlung unterzogenem Aluminiumdruckguss ausgestatteten Getriebe der Serie MODULAR verfügen über dieselben bakterientötenden Merkmale wie diejenigen der Serie PREMIUM, und ihre Korrosionsbeständigkeit ist standardmäßig (250 Stunden beim Test mit salzhaltigem Nebel NSS).

Das Außenprofil des Gehäuses ist daselbe wie bei den Standardgetrieben (den nicht GHA-behandelten). Im Vergleich zu den anderen Produktreihen gewährleistet die Serie GHA MODULAR dank des aus einem Teil bestehenden Gehäuses, das sich aufgrund der Bearbeitungstoleranzen aller Auflageflächen durch eine hohe Modularität in Bezug auf die Befestigung auszeichnet, eine erhöhte Vielseitigkeit. Andererseits ist das Gehäuse schwerer zu reinigen und die Getriebe dieser Serie sind nicht HACCP-zertifiziert, weshalb wir den Einsatz in trockener Lebensmittelumgebung empfehlen.

GX

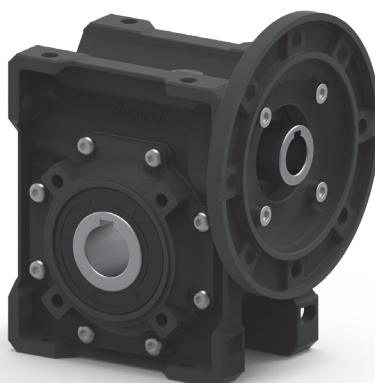

Tab. 1

SIMBOLO SYMBOL SYMBOL	DEFINIZIONE	DEFINITION	BEZEICHNUNG	UNITA' DI MISURA MEASUREMENT UNIT MAßEINHEIT
Fr₂	Carico Radiale	<i>Radial load</i>	Radialbelastung	N
Fa₂	Carico Assiale	<i>Axial load</i>	Axialbelastung	N
	Dimensioni	<i>Dimensions</i>	Abmessungen	mm
FS'	Fattore di servizio riduttore	<i>Gearbox service factor</i>	Betriebsfaktor des Getriebes	
FS	Fattore di servizio dell'applicazione	<i>Application service factor</i>	Betriebsfaktor der Anwendung	
i_n	Rapporto di riduzione	<i>Reduction ratio</i>	Untersetzungsverhältnis	
ir	Rapporto di trasmissione reale	<i>Actual reduction ratio</i>	Reelle Untersetzung	
n₁	Velocità albero entrata	<i>Input speed</i>	Antriebsdrehzahl	min⁻¹
n₂	Velocità albero uscita	<i>Output speed</i>	Abtriebsdrehzahl	min⁻¹
η	Rendimento	<i>Efficiency</i>	Wirkungsgrad	
IEC	Motori accoppiabili	<i>Motor options</i>	Passende Motoren	
kg	Massa	<i>Mass</i>	Masse	kg
P	Potenza riduttore	<i>Power gearbox</i>	Getriebeleistung	kW
P'	Potenza richiesta in entrata	<i>Power required at input</i>	Erforderliche Leistung am Antrieb	kW
Pc	Potenza corretta	<i>Corrected power</i>	Verbesserte Leistung	kW
P₁	Potenza motoriduttore	<i>Gearmotor power</i>	Getriebemotor Leistung	kW
P₂	Potenza in uscita	<i>Output power</i>	Abtriebsleistung	kW
P_{tc}	Potenza termica corretta	<i>Corrected thermal power</i>	verbesserte thermische Leistung	kW
P₁₀	Potenza termica	<i>Thermal power</i>	Thermische Leistung	kW
P'	Potenza richiesta in uscita	<i>Output power</i>	Erforderliche Abtriebsleistung	kW
Rd	Rendimento dinamico	<i>Dynamic efficiency</i>	Dynamischer Wirkungsgrad	
Rs	Rendimento statico	<i>Static efficiency</i>	statischer Wirkungsgrad	
Ta	Temperatura ambiente	<i>Ambient temperature</i>	Umgebungstemperatur	°C
T_{2M}	Momento torcente riduttore	<i>Gearbox torque</i>	Getriebe Drehmoment	Nm
T₂	Momento torcente motoriduttore	<i>Gear motor torque</i>	Getriebemotor Drehmoment	Nm
T_c	Momento torcente da utilizzare per la scelta del riduttore	<i>Torque to be used for the selection of the gearbox</i>	Drehmoment, das zur Wahl des Getriebe zu benutzen ist	Nm
T_{2'}	Momento torcente richiesto	<i>Required Torque</i>	benötigtes Drehmoment	Nm

1.2 Fattore di servizio

Il fattore di servizio **FS** permette di qualificare, in prima approssimazione, la tipologia dell'applicazione tenendo conto della natura del carico (A, B, C), della durata di funzionamento h/gg (ore giornaliere) e del numero di avviamenti/ora. Il coefficiente così trovato dovrà essere uguale o inferiore al fattore di servizio del riduttore **Fs'** dato dal rapporto fra la coppia nominale del riduttore **T_{2M}** indicata a catalogo e la coppia **T_{2'}** richiesta dall'applicazione.

1.2 Service factor

*Service factor **FS** enables approximate qualification of the type of application, taking into account type of load (A,B,C), length of operation h/d (hours/day) and the number of starts-up/hour. The coefficient thus calculated must be equal to or lower than the gear unit service factor **Fs'** which equals the ratio between **T_{2M}** (gear unit rated torque reported in the catalogue) and **T_{2'}** (torque required by the application).*

1.2 Betriebsfaktor

Der **FS** Betriebsfaktor ermöglicht die annähernde Bestimmung der Anwendungsart. Dabei werden Art der Last (A, B, C), Betriebsstunden pro Tag (S/T) und Anzahl der Starts pro Stunde berücksichtigt. Der so ermittelte Koeffizient sollte dem Betriebsfaktor **Fs'**, der sich aus dem Verhältnis zwischen Nenndrehmoment des Getriebes **T_{2M}** (s. Katalog) und dem für die Anwendung erforderlichen Drehmoment **T_{2'}** ergibt, entweder entsprechen oder niedriger liegen.

$$FS' = \frac{T_{2M}}{T_2'} > FS$$

1.2 Fattore di servizio

1.2 Service factor

1.2 Betriebsfaktor

I valori di FS indicati nella tab. 2, sono relativi all'azionamento con motore elettrico; se utilizzato un motore a scoppio, si dovrà tenere conto di un fattore di moltiplicazione 1.3 se a più cilindri e 1.5 se monocilindro. Se il motore elettrico applicato è autofrenante, considerare un numero di avviamenti doppio di quello effettivamente richiesto.

FS values reported in table 2 refer to a drive unit equipped with an electric motor. If an internal combustion engine is used, a multiplication factor of 1.3 must be applied for a several-cylinder engine, 1.5 for a single-cylinder engine. If the electric motor is self-braking, consider twice the number of starts-up than those actually required.

Die FS Werte, die in Tabelle 2 angegeben werden, beziehen sich auf den Antrieb mit Elektromotor; falls ein Explosionsmotor verwendet wird, ist ein Multiplikationsfaktor von 1.3 für Mehrzylindermotor und von 1.5 für Einzylindermotor zu berücksichtigen. Falls der verwendete Elektromotor ein Bremsmotor ist, so ist die Zahl der tatsächlich erforderlichen Startvorgänge doppelt zu zählen.

Tab. 2

Classe di carico Load class Lastklasse	h/gg h/d St./Tag	N. AVVIAMENTI/ORA / N. START-UP/HOUR / ANZAHL DER STARTVORGÄNGE PRO STUNDE								
		2	4	8	16	32	63	125	250	500
A	4	0.8	0.8	0.9	0.9	1.0	1.1	1.1	1.2	1.2
	8	1.0	1.0	1.1	1.1	1.3	1.3	1.3	1.3	1.3
	16	1.3	1.3	1.3	1.3	1.5	1.5	1.5	1.5	1.5
	24	1.5	1.5	1.5	1.5	1.8	1.8	1.8	1.8	1.8
	APPLICAZIONI / APPLICATIONS / ANWENDUNGEN									
Carico uniforme Uniform load Gleichmäßig verteilte Last	Agitatori per liquidi puri Alimentatori per fornaci Alimentatori a disco Filtri di lavaggio con aria Generatori Pompe centrifughe Trasportatori con carico uniforme			<i>Pure liquid agitators Furnace feeders Disc feeders Air laundry filters Generators Centrifugal pumps Uniform load conveyors</i>			Rührwerke für reine Flüssigkeiten Beschickungsvorrichtungen für Brennöfen Telleraufgeber Spülluftfilter Generatoren Kreiselpumpen Förderer mit gleichmäßig verteilter Last			
	APPLICAZIONI / APPLICATIONS / ANWENDUNGEN									
B	4	1.0	1.0	1.0	1.0	1.3	1.3	1.3	1.3	1.3
	8	1.3	1.3	1.3	1.3	1.5	1.5	1.5	1.5	1.5
	16	1.5	1.5	1.5	1.5	1.8	1.8	1.8	1.8	1.8
	24	1.8	1.8	1.8	1.8	2.2	2.2	2.2	2.2	2.2
	APPLICAZIONI / APPLICATIONS / ANWENDUNGEN									
Carico con urti moderati Moderate shock load Mässige Laststöße	Agitatori per liquidi e solidi Alimentatori a nastro Argani con medio servizio Filtri con pietre e ghiaia Viti per espulsione acqua Flocculatori Filtri a vuoto Elevatori a tazze Gru			<i>Liquid and solid agitators Belt conveyors Medium service winches Stone and gravel filters Dewatering screws Flocculator Vacuum filters Bucket elevators Cranes</i>			Rührwerke für Flüssigkeiten und Feststoffe Bandförderer Mittlere Winden Filter mit Steinen/Kies Abwasserschnecken Flockvorrichtungen Vakuumfilter Becherwerke Kräne			
	APPLICAZIONI / APPLICATIONS / ANWENDUNGEN									
C	4	1.3	1.3	1.3	1.3	1.5	1.5	1.5	1.5	1.5
	8	1.5	1.5	1.5	1.5	1.8	1.8	1.8	1.8	1.8
	16	1.8	1.8	1.8	1.8	2.2	2.2	2.2	2.2	2.2
	24	2.2	2.2	2.2	2.2	2.5	2.5	2.5	2.5	2.5
	APPLICAZIONI / APPLICATIONS / ANWENDUNGEN									
Carico con urti forti Heavy shock load Starke Laststöße	Argani per servizio pesante Estrusori Calandre per gomma Pressa per mattoni Piattatrici Mulini a sfera			<i>Heavy duty hoists Extruders Crusher rubber calendars Brick presses Planing machine Ball mills</i>			Winden für schwere Lasten Extruder Gummikalander Ziegelpressen Hobelmaschinen Kugelmühle			
	APPLICAZIONI / APPLICATIONS / ANWENDUNGEN									

1.3 Selezione

Determinare la potenza in entrata P' (in base alla coppia T_2 richiesta dall'applicazione) con la seguente formula:

1.3 Selection

Calculate input power P' (on the basis of the torque T_2 required by the application), using the following formula:

$$P' = \frac{T_2' \cdot n_2}{9550 \cdot \eta} \quad [\text{kW}]$$

1.3 Wahl

Bestimmen Sie die Antriebsleistung P' (je nach dem bei der Anwendung erforderlichen Drehmoment T_2) mit Hilfe der folgenden Formel:

Calcolare il rapporto di trasmissione con la relazione:

Calculate the transmission ratio with the following equation:

$$i_n = \frac{n_1}{n_2}$$

Berechnen Sie das Untersetzungsverhältnis mit Hilfe der Gleichung:

Scegliere il fattore di servizio FS dell'applicazione nella Tab. 2.

Select the service factor FS of the application in Table 2.

Wählen Sie den Betriebsfaktor FS der Anwendung aus der Tabelle 2 aus.

Scelta riduttore

A) $n_1 = 1400 \text{ min}^{-1}$

Si sceglierà nelle tabelle delle prestazioni dei riduttori un gruppo che in corrispondenza di un rapporto prossimo a quello calcolato ammetta una potenza:

Selecting a gearbox

A) $n_1 = 1400 \text{ min}^{-1}$

Consult the gear unit efficiency table; select a group whose ratio is close to the calculated ratio and which permits power:

Wahl des Getriebes

A) $n_1 = 1400 \text{ min}^{-1}$

Aus der Tabelle der Leistungen der Untersetzungsgetriebe wählt man eine Baugruppe aus, die ein ähnliches Untersetzungsverhältnis zu dem berechneten Wert aufweist und die die folgende Leistung zulässt:

$$P \geq P' \times \text{FS}$$

B) $n_1 \neq 1400 \text{ min}^{-1}$

Si dovrà effettuare la scelta come nel caso precedente però in base ad una potenza P_c corretta con i coefficienti riportati nelle tabelle relative ad ogni tipologia di riduttore verificando la relazione:

B) $n_1 \neq 1400 \text{ min}^{-1}$

Make the selection as described above but on the basis of power P_c corrected by the coefficients reported in the tables. The following equation should be checked out:

B) $n_1 \neq 1400 \text{ min}^{-1}$

Die Wahl wird wie im obigen Fall ausgeführt, allerdings auf der Basis einer Leistung P_c , die mit den Koeffizienten korrigiert wurde. Dabei ist das folgende Verhältnis zu überprüfen:

$$P_c \geq P' \times \text{FS}$$

Scelta del motoriduttore

C) $n_1 = 1400 \text{ min}^{-1}$ e $\text{FS} = 1$

Si cercherà nelle tabelle delle prestazioni dei motoriduttori un gruppo la cui potenza P_1 corrisponda alla P' calcolata.

D) $n_1 \neq 1400 \text{ min}^{-1}$ o se il fattore $\text{FS} \neq 1$

La scelta dovrà essere effettuata come al punto A) verificando che la grandezza del motore da installare sia compatibile con quelle ammesse dal riduttore (IEC); ovviamente la potenza installata dovrà corrispondere al valore P' richiesto.

Selecting a gearmotor

C) $n_1 = 1400 \text{ min}^{-1}$ and $\text{FS} = 1$

Consult the gear motor efficiency table and select a group having power P_1 corresponding to calculated P' .

D) $n_1 \neq 1400 \text{ min}^{-1}$ or $\text{FS} \neq 1$

Follow the instructions at point A), checking that the size of the motor to be installed is compatible with the gear unit (IEC); obviously, installed power must correspond to the required P' value.

Wahl des Getriebemotors

C) $n_1 = 1400 \text{ min}^{-1}$ und $\text{FS} = 1$

In den Leistungstabellen der Getriebemotoren sucht man eine Baugruppe, deren Leistung P_1 der berechneten Leistung P' entspricht.

D) $n_1 \neq 1400 \text{ min}^{-1}$ oder $\text{FS} \neq 1$

Die Auswahl wird wie unter A) getroffen, wobei zu überprüfen ist, ob die Größe des zu installierenden Motors mit dem Untersetzungsgetriebe kompatibel ist (IEC); selbstverständlich muß die Einbauleistung dem erforderlichen Wert P' entsprechen.

1.4 Carichi radiali e assiali (N)

Le trasmissioni effettuate tramite pignoni per catena, ruote dentate o pulegge generano delle forze radiali (F_R) sugli alberi dei riduttori. L'entità di tali forze può essere calcolata con la formula:

$$F_R = \frac{K_R \cdot T}{d} \text{ [N]}$$

dove:

T = Momento torcente [Nm]
d = Diametro pignone o puleggia [mm]

K_R = 2000 per pignone per catena
= 2500 per ruote dentate
= 3000 per puleggia con cinghie a V

I valori dei carichi radiali e assiali generati dall'applicazione debbono essere sempre minori o uguali a quelli ammissibili indicati nelle tabelle.

1.4 Radial and axial loads (N)

Transmissions implemented by means of chain pinions, wheels or pulleys generate radial forces (F_R) on the gear unit shafts. The entity of these forces may be calculated using the following formula:

where:

T = torque [Nm]
d = pinion or pulley diameter [mm]

K_R = 2000 for chain pinion
= 2500 for wheel
= 3000 for V-belt pulley

The values of the radial and axial loads generated by the application must always be lower than or equal to the admissible values reported in the tables.

$$F_R \geq Fr_2$$

Verifiche

Verificare che i carichi radiali agenti sugli alberi rientrino nei valori ammissibili riportati nelle relative tabelle.

Tali valori (F_{R2}) si riferiscono a carichi che agiscono a metà sporgenza dell'albero, per cui se il punto di applicazione è diverso, è necessario effettuare il calcolo dei nuovi valori ammissibili alla distanza (y) desiderata.

Analogamente a quanto precisato sopra, anche i carichi assiali dovranno essere oggetto di verifica confrontandoli con i valori delle relative tabelle.

Sovraccarichi

Durante il normale funzionamento del riduttore è ammesso un sovraccarico istantaneo di emergenza pari al 100% della coppia indicata T_2 .

Se si temono sovraccarichi frequenti o superiori è indispensabile prevedere degli opportuni dispositivi per la limitazione della coppia.

Ingranaggi

Il calcolo a durata ed a fatica degli ingranaggi viene eseguito secondo la norma ISO 6336 e ISO 10300, considerando l'impiego di olio sintetico.

Check-list

Check that the radial loads on the shafts fall within to the admissible values reported in the relative tables.

Reported values (F_{R2}) refer to loads which affect the shaft at the half-way point of its projection; if the point of application is different, it is necessary to calculate the new admissible values at the desired distance (y).

In keeping with the above guidelines, axial loads should also be checked against the values reported in the relative tables.

Overloads

An emergency momentary overload up to 100% of T_2 torque is allowed during standard operation of the gearbox.

Should frequent or higher overloads be expected, it is necessary to install torque limiting devices.

Gears

Life and fatigue of the gears are calculated in compliance with ISO 6336 and ISO 10300. Calculations refer to utilization of synthetic oil

1.4 Radial- und Axialbelastungen (N)

Antriebe mit Kettenritzel, Zählrädern oder Riemenscheiben erzeugen radiale Kräfte (F_R) an den Wellen der Untersetzungsgetriebe. Das Ausmaß dieser Kräfte kann nach folgender Formel berechnet werden:

dabei ist:

T = Drehmoment [Nm]
d = Kettenritzel- bzw. Riemenscheiben durchmesser [mm]

K_R = 2000 bei Kettenritzel
= 2500 bei Zahnrad
= 3000 bei Riemenscheibe mit Keilriemen

Die Werte der Radial- und Axialbelastungen, die durch die Anwendung hervorgerufen werden, dürfen nicht über den in den Tabellen angegebenen zulässigen Werten liegen.

Überprüfungen

Es ist zu überprüfen, ob die, dass die auf die Wellen wirkenden Radiallasten unter den in der Tabellen angegebenen zulässigen Werten fallen.

Werte beziehen sich auf Lasten, die in der F_{R2} Mitte der herausragenden Welle wirken; bei verschiedenem Ansatzpunkt ist es daher erforderlich, die neuen, beim gewünschten Abstand (y) zulässigen Werte zu berechnen.

Ähnlich wie oben, müssen auch Axialbelastungen überprüft werden, indem man sie mit den Werten der jeweiligen Tabellen vergleicht.

Überbelastungen

Eine augenblickliche Notfall-Überbelastung zu 100% des T_2 Drehmoments darf während Getriebestandardbetrieb eintreten.

Falls häufige und höhere Überlastungen erwartet werden, sind die entsprechenden Vorrichtungen zur Begrenzung des Drehmoments anzubringen.

Räderwerk

Dauer und Belastung werden gemäß ISO 6336 und ISO 10300 berechnet. Dabei wird die Anwendung von synthetischem Öl berücksichtigt

1.5 Potenza Termica

Nelle tabelle riportate nelle sezioni relative ad ogni tipologia di riduttore sono indicati i valori della potenza termica nominale P_{t0} (kW). Tale valore rappresenta la potenza massima applicabile all'entrata del riduttore, in servizio continuo a temperatura ambiente di 30°C, così che la temperatura dell'olio non oltrepassi il valore di 95°C, valore massimo ammesso nel caso di prodotti standard.

Il valore di P_{t0} non deve essere preso in considerazione se il funzionamento è continuo per un massimo di 1.5 ore seguito da pause di durata sufficiente (circa 1 – 2 ore) a ristabilire nel riduttore la temperatura ambiente.

I valori di P_{t0} devono essere corretti tramite i seguenti coefficienti, così da considerare le reali condizioni di funzionamento, ottenendo i valori di potenza termica corretta P_{tc} .

1.5 Thermal power

The different sections dedicated to each type of gearbox contain tables reporting the values of rated thermal power P_{t0} (kW). Reported values correspond to the maximum admissible power at gearbox input, on continuous duty and with ambient temperature of 30°C, so that oil temperature does not exceed 95°C, which is the max. admissible value for standard products.

P_{t0} value should not be taken into account in case of continuous duty for max. 1.5 hours followed by pauses which are long enough to bring the gearbox back to ambient temperature (roughly 1 – 2 hours).

In order to comply with the actual operating conditions, P_{t0} values should be corrected with the following coefficients, thus obtaining the values of corrected thermal power P_{tc} .

1.5 Thermische Leistung

Für jeden Getriebetyp gibt es Tabellen, die die Nennwerte der thermischen Leistung P_{t0} (kW) angeben. Die angegebenen Werte stellen die max. anwendbare Antriebsleistung der Getriebe im Dauerbetrieb mit einer Umgebungstemperatur von max. 30°C dar, sodass die Öltemperatur unter 95°C bleibt (max. Wert für Standardprodukte).

P_{t0} Wert darf nicht betrachtet werden, falls Dauerbetrieb max. 1.5 Stunden dauert und von Stillstand gefolgt wird, der lang genug ist, damit das Getriebe zur Umgebungstemperatur zurück kommt. (ungefähr 1 – 2 Stunden).

P_{t0} Werte sollen durch die folgenden Koeffizienten verbessert werden. Damit die realen Betriebsbedingungen wirklich in Betracht gezogen werden. Mit der folgenden Formel erhält man die Werte der korrekten thermischen Leistung P_{tc} .

$$P_{tc} = P_{t0} \cdot ft \cdot fv \cdot fu \text{ (kW)}$$

Dove:

ft = coefficiente di temperatura (v. tab. 3)

Where:

ft = temperature coefficient (see table 3)

Dabei ist:

ft = Temperaturkoeffizient (siehe Tabelle 3)

Tab. 3

Tc (°C)	0	5	10	15	20	25	30	35	40	45	50
ft	1.46	1.38	1.31	1.23	1.15	1.1	1	0.92	0.85	0.77	0.69

(Dove Tc (°C) è la temperatura ambiente)

(Tc (°C) is the ambient temperature)

(Tc (°C) ist die Umgebungstemperatur)

fv = coefficiente di ventilazione

- fv= 1.45 con ventilazione forzata efficace con ventola dedicata
- fv= 1.25 con ventilazione forzata secondaria ad altri dispositivi (pulegge, ventole motore, ecc.)
- fv= 1 refrigerazione naturale (situazione standard)
- fv= 0.5 in ambiente chiuso e ristretto (carter)

fv = cooling coefficient

- fv= 1.45 forced cooling with specific fan
- fv= 1.25 forced cooling secondary to other devices (pulleys, motor fans, etc)
- fv= 1 natural cooling (standard)
- fv= 0.5 in a closed and narrow environment

fv = Luftkühlungskoeffizient

- fv= 1.45 Drucklüftung mit Sonderlüfterrad
- fv= 1.25 Drucklüftung nebensächlich zu anderen Vorrichtungen (Scheiben, Motorlüfterräder, usw.)
- fv= 1 natürliche Lüftung (Standard)
- fv= 0.5 in engem und geschlossenem Raum

fu = coefficiente di utilizzo (v. tab. 4)

fu = utilization coefficient (see table 4)

fu = Verwendungskoeffizient (siehe Tabelle 4)

Tab. 4

Dt (min)	10	20	30	40	50	60
fu	1.6	1.35	1.2	1.1	1.05	1

Dove Dt sono i minuti di funzionamento in un'ora

Dt is minutes of operation per hour

Dt steht für Betriebsminuten pro Stunde

1.6 Lubrificazione

Tutti i riduttori sono forniti completi di lubrificante sintetico a base PAG con indice di viscosità ISO VG 320 e ISO VG150 (solo GHA PREMIUM).

I cuscinetti dell'albero veloce vengono sempre lubrificati con grasso a base sintetica per tutte le posizioni di montaggio. Solamente per le pos. B6-B7, per una corretta lubrificazione, vengono ingrassati anche i cuscinetti dell'albero lento. Questo significa che solamente dalle posizioni di montaggio B6-B7 si può passare a tutte le altre posizioni, modificando esclusivamente le quantità di olio, come indicato nelle relative tabelle. Per quanto riguarda invece le posizioni di montaggio B3-B8-V5-V6, possono essere intercambiabili solo tra di loro, modificando le quantità di olio per la serie Premium, senza modificare le quantità di olio per la serie CLASSIC e MODULAR.

Il grasso utilizzato è il FUCHS CASSIDA GREASE HTS2.

Una scelta oculata del tipo di lubrificante, in funzione delle condizioni operative e ambientali, consente ai riduttori di raggiungere le prestazioni ottimali.

Le prestazioni dei riduttori indicate nelle tabelle dei dati tecnici sono state calcolate considerando l'impiego di olio sintetico alimentare: OLIO FUCHS CASSIDA FLUID 150 per GHA; OLIO FUCHS CASSIDA FLUID 320 per GK, GT, GX.

Per campo di applicazione marino (M), si utilizzano lubrificanti della serie vite senza fine standard TRAMEC.

1.7 Installazione

Montare il riduttore in modo tale da eliminare qualsiasi vibrazione.

Curare particolarmente l'allineamento del riduttore con il motore e la macchina da comandare interponendo dove è possibile giunti elastici od autoallineanti.

Quando il riduttore è sottoposto a sovraccarichi prolungati, urti o pericoli di bloccaggio, installare salvamotori, limitatori di coppia, giunti idraulici od altri dispositivi similari.

Fare attenzione a non superare i valori consentiti di carico radiale ed assiale che agiscono sugli alberi veloce e lento.

Assicurarsi che gli organi da montare sui riduttori siano lavorati con tolleranza **ALBERO ISO h6 FORO ISO H7.**

1.6 Lubrication

All the reducers are supplied complete with PAG-based synthetic lubricant with ISO VG 320 and ISO VG150 viscosity index (only GHA PREMIUM).

The input shaft bearings are always lubricated with synthetic grease for all assembly positions. Only for positions B6-B7, for correct lubrication, the output shaft bearings are also greased. This means that only from assembly positions B6-B7 it is possible to switch to all the other positions, modifying solely the amounts of oil, as indicated in the relative tables. While with regard to assembly positions B3-B8-V5-V6, they are only interchangeable between them, modifying the amounts of oil for the Premium series, without modifying the amounts of oil for the CLASSIC and MODULAR series.

The grease used is FUCHS CASSIDA GREASE HTS2.

A careful choice of the type of lubricant, depending on the operating and environmental conditions, allows the reducers to achieve optimum performance.

The performance of the reducers indicated in the technical data tables have been calculated considering the use of synthetic food oil: FUCHS CASSIDA FLUID OIL 150 for GHA; FUCHS CASSIDA FLUID OIL 320 for GK, GT, GX.

For the marine application field (M), standard TRAMEC worm gear series lubricants are used.

1.7 Installation

Install the gearbox so that any vibration is eliminated.

Take special care with the alignment between the gear units, the motor and the driven machine, fitting flexible or self adjusting couplings wherever possible.

If the gearbox is subject to prolonged overloads, shocks or possible jamming, fit overload cutouts, torque limiters, hydraulic couplings or other similar devices.

Do not exceed allowed radial and axial loads on the input and output shafts.

*Ensure that the components to be fitted on the gear units are machined with tolerance **SHAFT ISO h6 HOLE ISO H7.***

1.6 Schmierung

Alle Getriebe werden einschließlich synthetischem Schmierstoff auf Basis von PAG mit Viskositätsindex ISO VG 320 und ISO VG150 (nur GHA PREMIUM) geliefert.

Die Lager der Antriebswelle werden in allen Einbaulagen immer mit synthetischem Fett geschmiert. Nur bei den Pos. B6-B7 werden für eine sachgemäße Schmierung auch die Lager der Abtriebswelle geschmiert. Das bedeutet, dass lediglich von den Einbaulagen B6-B7 aus auf alle anderen Positionen übergegangen werden kann, indem ausschließlich die Ölmenge geändert wird, wie in den Tabellen dargestellt. Was hingegen die Einbaulagen B3-B8-V5-V6 betrifft, so können sie nur untereinander durch eine Änderung der Ölmenge für die Serie Premium ausgetauscht werden, ohne dabei die Ölmengen für die Serie CLASSIC und MODULAR zu ändern.

Als Schmierfett wird FUCHS CASSIDA GREASE HTS2 verwendet.

Eine sorgfältige Auswahl des Schmierstofftyps auf Grundlage der Betriebs- und Umweltbedingungen, ermöglicht eine optimale Leistung der Getriebe.

Die in den Tabellen der technischen Daten angegebenen Leistungen der Getriebe wurden unter Berücksichtigung der Verwendung von synthetischem Speiseöl berechnet: SCHMIERÖL FUCHS CASSIDA FLUID 150 für GHA; SCHMIERÖL FUCHS CASSIDA FLUID 320 für GK, GT, GX.

Für Schifffahrts-Anwendungen (M) werden Schmierstoffe der Serie Standard-Schneckengetriebe von TRAMEC verwendet.

1.7 Einbau

Das Getriebe ist so zu montieren, daß Schwingungen ausgeschaltet werden.

Insbesondere ist auf die Fluchtung des Getriebes zum Motor und zur Maschine zu achten, wo möglich sind elastische oder selbstfluchtende Kupplungen anzubringen.

Wenn das Getriebe anhaltenden Überlasten, Schlägen oder Blockierungsgefahr ausgesetzt ist, sind Motorschalter, Drehmomentbegrenzer, hydraulische Kupplungen oder ähnliche Vorrichtungen anzubringen. Achten sie darauf, dass die zulässigen Radial- und Axialbelastungen an Antriebs- und Abtriebswelle nicht überschritten werden.

Achten Sie darauf, dass die am Getriebe montierten Elemente mit folgenden Toleranzen bearbeitet sind: **WELLE ISO h6, BOHRUNG ISO H7.**

Prima di effettuare il montaggio pulire e lubrificare le superfici al fine di evitare il pericolo di grippaggio e l'ossidazione da contatto.

Before assembling, clean and lubricate the surfaces to prevent seizure and contact oxidation.

Vor der Montage sind die Flächen zu reinigen und zu schmieren, um Festfressen bzw. Kontaktoxidation zu vermeiden.

Il montaggio va effettuato con l'ausilio di tiranti ed estrattori utilizzando il foro filettato posto in testa alle estremità degli alberi.

Assembly is to be carried out with the aid of tie-rods and extractors, using the threaded hole at the shaft ends.

Die Montage erfolgt mit Hilfe von Zugstangen und Ausziehvorrichtungen unter Verwendung der Gewindebohrung vorn an den Wellenenden.

Tutti i riduttori e motoriduttori citati nel presente manuale sono destinati ad un impiego industriale con temperatura ambiente da -20°C a +40°C ad una altitudine max di 1000 m slm.

All gearboxes and gear motors mentioned in this catalog are intended for industrial use and operation at a ambient temperature between -20°C and +40°C, at an altitude of max. 1000 m above sea level.

Alle im vorliegenden Katalog angegebenen Getriebe und Getriebemotoren sind für industriellen Einsatz in einer Umgebungstemperatur von -20°C bis +40°C und in einer max. Höhe von 1000 m über dem Meeresspiegel vorgesehen.

Per tutte le altre avvertenze consultare il manuale di "uso e manutenzione" scaricabile dal sito www.tramec.it

For all other instructions check the "Use and Maintenance Manual" which can be downloaded from our web site www.tramec.it

Für weitere Anweisungen laden Sie die "Betriebs- und Instandhaltungsanweisung" aus unsere Webseite www.tramec.it herunter.

1.8 Rodaggio

1.8 Running-in

1.8 Einfahren

Si consiglia di incrementare gradualmente nel tempo la potenza trasmessa oppure limitare il momento torcente resistente della macchina da comandare per le prime ore di funzionamento.

Increase the transmitted power gradually or limit the resistant torque of the driven machine for the first few operating hours.

Es ist ratsam, die Leistung nur allmählich zu steigern oder das Widerstandsdrehmoment der Maschine in den ersten Betriebsstunden zu begrenzen.

1.9 Manutenzione

1.9 Maintenance

1.9 Wartung

Controllare periodicamente il livello del lubrificante ed effettuare il cambio dopo 12500 ore di funzionamento.

Check the lubricant level regularly and change after 12500 operating hours.

Von Zeit zu Zeit ist der Ölstand zu prüfen, alle 12500 Betriebsstunden sollte ein Ölwechsel stattfinden.

Quando il riduttore resta per lungo tempo inattivo in un ambiente con una elevata percentuale di umidità si consiglia di riempirlo completamente di olio. Naturalmente al momento della successiva messa in funzione sarà necessario ripristinare il livello del lubrificante.

When the gearbox is left unused in a highly humid environment fill it completely with oil. Importantly the oil must be returned to the operating level before the unit is used again.

Wenn das Getriebe lange Zeit in einem Raum mit hoher Luftfeuchtigkeit stillliegt, ist es ratsam, es ganz mit Öl zu füllen. Wird es danach wieder in Betrieb genommen, so ist natürlich vorher der richtige Ölstand wiederherzustellen.

1.10 Operazioni di lavaggio

Sui riduttori della serie PREMIUM è ammessa la pulizia mediante getto d'acqua in pressione. Per garantire la massima durabilità del riduttore, in prossimità dell'albero cavo uscita, pur avendo una copertura che arriva a proteggere le tenute fino a 0,2 mm dall'albero, si invita a non direzionare il getto in pressione nella zona di interfaccia tra albero cavo e carcassa.

Per i riduttori GKC, GXC e GTF bisogna garantire una certa accortezza alle tenute evitando di indirizzare getti d'acqua in pressione contro questi

I riduttori GHA PREMIUM possono essere lavati con soluzioni di detergenti e/o disinfettanti o sanificanti professionali. Per conservare nel tempo le proprietà del trattamento superficiale, alcuni principi attivi sono più idonei di altri. In particolare alcuni sono molto aggressivi. La scelta è importante!

Sulla base di test eseguiti con soluzioni di detergenti e/o disinfettanti o sanificanti è emerso che:

- **L'acido peracetico** ed i **Sali ammonio quaternario** sono i principi attivi più idonei per le superfici del GHA Premium.

- **L'ipoclorito** è un principio attivo che tende ad opacizzare le superfici ma che consente comunque di eseguire 270 cicli di lavaggio prima di arrivare a deterioramento delle superfici.

- **L'idrossido di sodio/potassio** è un principio attivo incompatibile con il trattamento G.H.A..

1.10 Washing operations

On the PREMIUM series reducers, cleaning with a pressurised water jet is permitted. To ensure the maximum durability of the reducer, near the hollow output shaft, despite having a cover that protects the seals up to 0.2 mm from the shaft, it is recommended not to direct the pressurised jet in the interface area between the hollow shaft and the casing.

For GKC, GXC and GTF reducers, the seals must be treated carefully, avoiding pressurised jets of water directed on them.

GHA PREMIUM reducers can be washed with detergent and/or disinfectant or professional sanitising solutions. To preserve the properties of the surface treatment over time, some active ingredients are more suitable than others. In particular, some are very harsh. The choice is important!

On the basis of tests carried out with detergent and/or disinfectant or sanitising solutions, the following emerged:

- peracetic acid and quaternary ammonium salts are the most suitable active ingredients for GHA Premium surfaces.

- Hypochlorite is an active ingredient that tends to tarnish the surfaces but which still allows 270 washing cycles to be carried out before deteriorating the surface.

- Sodium/potassium hydroxide is an active ingredient incompatible with G.H.A..

1.10 Reinigungsverfahren

Für die Getriebe der Serie PREMIUM ist die Reinigung mittels Hochdruck-Wasserstrahl zulässig. Um die maximale Lebensdauer des Getriebes zu gewährleisten, wird empfohlen, den Wasserstrahl in der Nähe der Abtriebs-hohlwelle nicht auf den Verbindungsbereich zwischen Hohlwelle und Gehäuse zu richten, obwohl eine Abdeckung vorhanden ist, die die Dichtungen bis zu einem Abstand von 0,2 mm von der Welle schützt.

Bei den Getrieben GKC, GXC und GTF ist es notwendig, eine gewisse Sorgfalt in Bezug auf die Dichtungen walten zu lassen und keine direkten Wasserstrahlen auf sie zu richten.

Die Getriebe GHA PREMIUM können mit professionellen Reinigungs- und/oder Desinfektionslösungen gereinigt werden. Um die Eigenschaften der Oberflächenbehandlung im Laufe der Zeit aufrecht zu erhalten, sind einige Wirkstoffe besser geeignet als andere. Insbesondere sind einige von ihnen äußerst aggressiv. Die richtige Wahl ist von grundlegender Bedeutung!

Tests mit Reinigungs- und/oder Desinfektionslösungen haben Folgendes gezeigt:

- **Peressigsäure** und **quaternäre Ammoniumsalze** sind die am besten geeigneten Wirkstoffe für die Oberflächen des GHA Premium.

- **Hypochlorit** ist ein Wirkstoff, der dazu neigt, Oberflächen zu trüben, mit dem aber doch 270 Reinigungszyklen durchgeführt werden können, bevor es zu einer Beschädigung der Oberflächen kommt.

- **Natriumhydroxid/Kalium** ist ein Wirkstoff, der mit der G.H.A.-Behandlung nicht kompatibel ist.

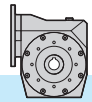

2.0	RIDUTTORI A VITE SENZA FINE GHA	GHA WORM GEARBOXES	SCHNECKENGETRIEBE GHA	
2.1	Caratteristiche	<i>Characteristics</i>	Merkmale	22
2.2	Designazione	<i>Designation</i>	Bezeichnung	23
2.3	Rendimento	<i>Efficiency</i>	Wirkungsgrad	24
2.4	Irreversibilità	<i>Irreversibility</i>	Selbsthemmung	24
2.5	Gioco angolare	<i>Backlash</i>	Winkelspiel	25
2.6	Carichi radiali	<i>Radial load</i>	Radialbelastungen	26
2.7	Senso di rotazione	<i>Direction of rotation</i>	Drehrichtung	26
2.8	Lubrificazione e posizioni di montaggio	<i>Lubrication and mounting position</i>	Schmierung und Einbaulage	27
2.9	Posizione morsettiera	<i>Terminal board position</i>	Lage des Klemmbrett	27
2.10	Posizione pressacavo	<i>Cable gland position</i>	Position Klemmenkasten	
2.11	Dati tecnici	<i>Technical data</i>	Technische Daten	29
2.12	Momenti d'inerzia	<i>Moment of inertia</i>	Trägheitsmoment	31
2.13	Dimensioni	<i>Dimensions</i>	Abmessungen	32
2.14	Accessori	<i>Accessories</i>	Zubehör	35
2.15	Lista parti di ricambio	<i>Spare parts list</i>	Ersatzteilliste	36

GHA - PREMIUM

La serie PREMIUM rappresenta la serie di punta all'interno della gamma di riduttori GHA, in virtù delle speciali caratteristiche NANOTECHNOLOGICHE potenziate del rivestimento.

Il trattamento GHA potenziato ed il particolare design esterno a superficie liscia rendono i riduttori della serie PREMIUM la soluzione ideale per un'ampia gamma di applicazioni in ambienti sensibili nei settori ALIMENTARE, FARMACEUTICO e MARINO.

Nonostante i riduttori delle serie GHA PREMIUM siano certificati come dispositivi idonei per l'utilizzo su macchine alimentari e dunque per applicazioni che operano in impianti di produzione e di manipolazione degli alimenti, essi non sono certificati per l'utilizzo a contatto con gli alimenti.

GHA - PREMIUM

The PREMIUM series represents the flagship series within the range of GHA reducers, thanks to the special enhanced NANOTECHNOLOGICAL characteristics of the coating.

The enhanced GHA treatment and the particular external design with its smooth surface make the PREMIUM series reducers the ideal solution for a wide range of applications in sensitive environments in the FOOD, PHARMACEUTICAL and MARINE sectors.

Although the GHA PREMIUM series reducers are certified as suitable devices for use on food processing machines and therefore for applications that operate in food production and handling plants, they are not certified for use in contact with food.

GHA - PREMIUM

Die Serie PREMIUM stellt die Spitzenbaureihe der GHA-Getriebe dar, da sie über spezielle, verstärkte NANOTECHNOLOGISCHE Merkmale an der Beschichtung verfügt.

Dank der verstärkten GHA-Behandlung und dem besonderen äußeren Design mit glatter Außenoberfläche stellen die Getriebe der Serie PREMIUM die ideale Lösung für eine große Anzahl von Anwendungen in empfindlichen Bereichen in der LEBENSMITTEL-, PHARMA- UND SCHIFFFAHRTSBRANCHE dar.

Obwohl die Getriebe der Baureihe GHA PREMIUM als Geräte zertifiziert sind, die für den Einsatz in Lebensmittelmaschinen und damit für Anwendungen in Anlagen zur Produktion und Handhabung von Lebensmitteln geeignet sind, sind sie nicht für den Einsatz in Kontakt mit Lebensmitteln zugelassen.



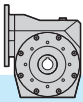

2.1 Caratteristiche

- I riduttori della serie a vite senza fine GHA PREMIUM presentano, per tutte le grandezze, una forma compatta della carcassa.
- La carcassa e le flange in lega di alluminio sono burattate e trattate con tecnologia G.H.A..
- La serie GHA PREMIUM è disponibile esclusivamente nella versione predisposta per attacco motore (PAM) e non con albero entrata maschio.
- La vite senza fine è in acciaio legato cementato-temprato ed è rettificata.
- La corona ha il mozzo in acciaio INOX AISI 316 e l'anello dentato in bronzo GCuSn12.
- Provvisti di bulloneria INOX, tenute in materiale certificato FDA e lubrificanti per l'industria alimentare (categoria di certificazione NSF H1).
- Per applicazioni nel settore marino (M) non si utilizzano lubrificanti NSF H1 e tenute in materiale certificato FDA.
- Viene fornito l'albero uscita cavo di serie, in acciaio INOX AISI 316 ed esiste la disponibilità dell'accessorio braccio di reazione in lega di alluminio con trattamento G.H.A., montato con viti in acciaio inox.

2.1 Characteristics

- *The GHA PREMIUM worm gear series reducers feature a compact casing for all sizes.*
- *The casing and the flanges made of aluminium alloy are tumbled and treated with G.H.A technology.*
- *The GHA PREMIUM series is only available in the version designed for motor coupling (PAM) and not with a male input shaft.*
- *The worm gear is made of cemented-tempered alloy steel and is ground.*
- *The crown wheel features an AISI 316 stainless steel hub and a GCuSn12 bronze toothed ring.*
- *Equipped with stainless steel nuts and bolts, seals made of FDA-certified material and lubricants for the food industry (NSF H1 certification category).*
- *For applications in the marine sector (M), NSF H1 lubricants and FDA-certified seals are not used.*
- *The hollow output shaft is supplied as standard in AISI 316 stainless steel and there is also a reaction arm accessory available, made of aluminium alloy with G.H.A. treatment, mounted with stainless steel screws.*

2.1 Merkmale

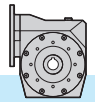

- Die Schneckengetriebe der Serie GHA PREMIUM weisen in allen Baugrößen eine kompakte Gehäuseform auf.
- Das Gehäuse und die Flansche aus Aluminiumlegierung sind sandgestrahlt und mit G.H.A.-Technologie hergestellt.
- Die Serie GHA PREMIUM ist ausschließlich in der Version mit Vorrüstung für den Motoranschluss (PAM) und nicht mit Eingangswelle mit Außengewinde erhältlich.
- Die Schneckenwelle besteht aus einsatzgehärtetem, abgeschrecktem und daraufhin geschliffenem Legierungsstahl.
- Das Schneckenrad besteht aus einer Nabe aus Edelstahl AISI 316 und einer Bronze- Verzahnung GCuSn12.
- Ausgestattet mit Edelstahlschrauben, Dichtungen aus FDA-zertifiziertem Material und Schmierstoffen für die Lebensmittelindustrie (Zertifizierungskategorie NSF H1).
- Für Anwendungen im Schifffahrtsbereich (M) werden keine NSF H1-Schmierstoffe und Dichtungen aus FDA-zertifiziertem Material verwendet.
- Die hohle Abtriebswelle wird standardmäßig aus Edelstahl AISI 316 geliefert und als Zubehör ist ein Reaktionsarm aus Aluminiumlegierung mit G.H.A.-Behandlung und mit Edelstahlschrauben montiert verfügbar.



2.2 Designazione

2.2 Designation

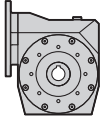
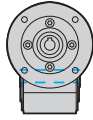
2.2 Bezeichnung

Riduttore Gearbox Getriebe	Grandezza Size Größe	Versione Version Ausführung	Rapporto rid. Ratio Untersetzung	Predispos. att. mot. Motor coupling Motorschluss	Posizione di mont. Mounting position Einbaulage	Albero uscita cavo Hollow output shaft Abtriebshohlwelle	Braccio di reazione Torque arm Drehmomentstütze	Campo di applicazione Field of application Anwendungsbereich
GHA	50	PP	10/1	P.A.M	B3	H25	BR	A
	30 40 50 63 75	PP CC PD PS	5 7.5 10 15 20 25 30 40 50 65 80 100	56 B14 63 B14 71 B14 80 B14 90 B14 100 B14 112 B14	B3, B6 B7, B8 V5, V6	 H..	 BR	A Alimentare e Farmaceutico Food and Pharmaceutical Lebensmittel- und Pharmaindustrie M * Marino Marine Schifffahrt

*: a richiesta

*: on request

*: auf Anfrage

GHA...PP

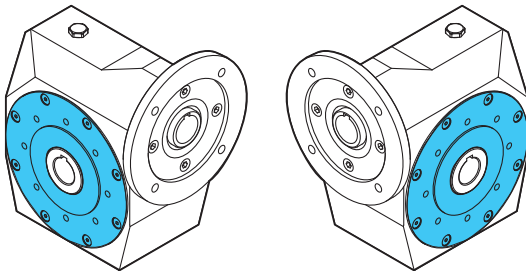

GHA...CC

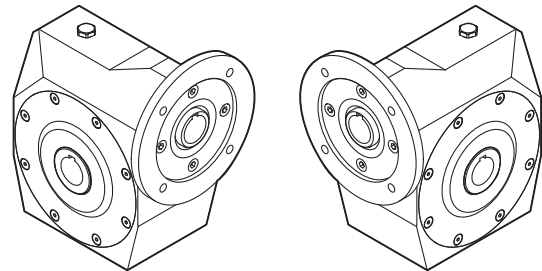

GHA...PD

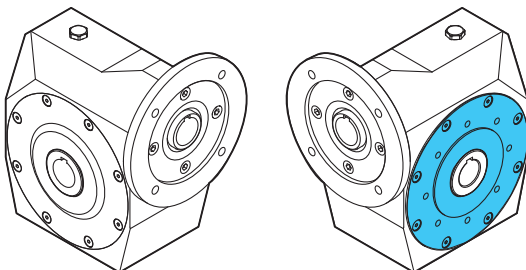

GHA...PS

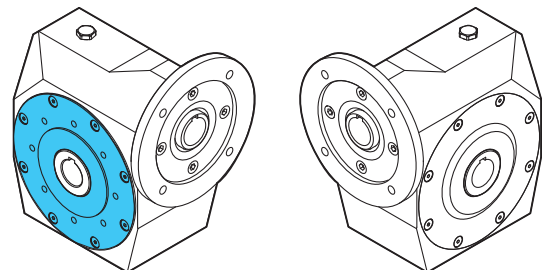

Note:

PP = Doppia flangia pendolare
CC = Doppio coperchio
PD = Coperchio e flangia pendolare destra
PS = Coperchio e flangia pendolare sinistra

Notes:

PP = Double shaft-mounted flange
CC = Double cover
PD = Cover and right hand shaft-mounted flange
PS = Cover and left hand shaft-mounted flange

Anmerkungen:

PP = Doppelter Pendelflansch
CC = Doppelter Deckel
PD = Deckel und Pendelflansch rechts
PS = Deckel und Pendelflansch links

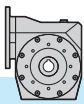

2.3 Rendimento

Rd - È il rendimento dinamico, definito come rapporto tra la potenza in uscita P_2 e quella in entrata P_1 . Dipende principalmente dalla velocità di strisciamento, dal tipo di lubrificante e dall'angolo d'elica. I valori indicati nelle tabelle sono validi se si applica la corrispondente coppia in uscita. In fase di rodaggio, circa le prime 300 ore di funzionamento sotto carico, il valore deve essere considerato inferiore del 30% rispetto a quello indicato in tabella.

Rs - È il rendimento statico che si ha al momento dell'avviamento del riduttore e varia in base al rapporto di riduzione. Risulta importante, per una corretta valutazione del riduttore da impiegare, nelle applicazioni in cui non si raggiungono mai le condizioni di regime come nei funzionamenti intermittenti. Analogamente al caso dinamico, anche il rendimento statico durante il rodaggio risulta inferiore del 30% rispetto al valore indicato in tabella.

2.3 Efficiency

Rd - dynamic efficiency, defined as the ratio between P_2 output power and P_1 input power. It mainly depends on the slipping speed, the type of lubricant and the lead angle. The values reported in the table are valid when the corresponding output torque is applied. During the first 300 operating hours under load, the value to be considered is 30% lower than that reported in the table.

Rs - static efficiency at gearbox start-up; it changes depending on the reduction ratio. Rs value is important for selecting the right gearbox for applications where a steady state is never achieved, as for intermittent duty applications. Same as dynamic efficiency, static efficiency too during the running-in period will be 30% lower than the value reported in the table.

2.3 Wirkungsgrad

Rd - dynamischer Wirkungsgrad, ist das Verhältnis zwischen P_2 Abtriebsleistung und P_1 Antriebsleistung. Rd Wert wird durch Gleitgeschwindigkeit, Art des Schmiermittels und Steigungswinkel beeinflusst. Die Tabellen zeigen die Werte die gültig sind wenn das entsprechende Abtriebsdrehmoment gegeben ist. Während der Einlaufzeit in den ersten 300 Betriebsstunden unter Belastung, ist dieser Wert 30% niedriger als der in der Leistungstabelle angegebenen Wert.

Rs - statischer Wirkungsgrad beim Getriebebestart und in Abhängigkeit zur Unterersetzung. Der Wert Rs ist wichtig für die Auswahl des richtigen Getriebes für Anwendungen wo ein stetiger Betrieb nicht auftritt, wie bei Anwendungen mit Aussetzbetrieb. Der statischer Wirkungsgrad auch während der Einlaufzeit wird 30% niedriger als der in der Tabelle angegebenen Wert.

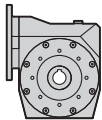

GHA	Rs											
	5	7.5	10	15	20	25	30	40	50	65	80	100
30	0.70	0.67	0.62	0.55	0.47	0.43	0.39	0.30	0.27	0.25	0.22	0.21
40	0.69	0.67	0.63	0.55	0.52	0.45	0.40	0.35	0.29	0.26	0.25	0.23
50	0.69	0.68	0.65	0.58	0.53	0.47	0.41	0.37	0.32	0.28	0.25	0.23
63	0.70	0.68	0.65	0.57	0.55	0.50	0.47	0.38	0.33	0.29	0.28	0.23
75	/	0.68	0.65	0.58	0.55	0.51	0.43	0.39	0.35	0.31	0.28	0.24

2.4 Irreversibilità

Nelle applicazioni dove è necessario evitare la trasmissione del moto retrogrado o sostenere il carico, in assenza di alimentazione elettrica, è consigliabile adottare freni esterni.

Nei riduttori a vite senza fine emerge questa caratteristica naturale, denominata grado di irreversibilità, che cresce con l'aumentare del rapporto di riduzione in quanto strettamente legata al relativo rendimento.

Per ottenere alti gradi di irreversibilità occorre quindi adottare i rapporti di riduzione più elevati, senza dimenticare che, il rendimento, tende a crescere durante le prime 500 ore di funzionamento per poi stabilizzarsi sui valori riportati a catalogo.

2.4 Irreversibility

The use of external brakes is advised in case of applications where backwards motion must be hindered and the load must be held should the feed be cut off.

Some worm gearboxes feature natural irreversibility. The higher the ratio, the higher is the irreversibility, since it is strictly dependent on the relative efficiency.

In order to achieve high irreversibility it is therefore necessary to select higher efficiency reduction ratios not to forget that the efficiency is growing during the first 500 hours life until it stabilizes to the values mentioned in the catalogue.

2.4 Selbsthemmung

Aussenbremsen sind bei Anwendungen zu benutzen, bei denen Rückbewegung vermeiden werden muss oder die Last auch im Falle von Fehlen an Speisung gehalten werden muss.

Einige Schneckengetriebe sind selbsthemmend. Je höher die Unterersetzung ist, desto höher ist die Selbsthemmung, da diese stark vom jeweiligen Wirkungsgrad abhängig ist. Um eine höhere Selbsthemmung zu erreichen, wählen Sie bitte höhere Untersetzungsverhältnisse.

Bitte beachten Sie, dass der Wirkungsgrad der Getriebe in den ersten 500 Betriebsstunden ansteigt und sich erst anschließend auf die im Katalog angegebenen Werte stabilisiert.

Irreversibilità statica

Condizione di impedimento alla rotazione comandata dall'albero lento senza escludere possibili ritorni lenti nel caso in cui il carico sia sottoposto a vibrazioni.

Rs < 0.45 si ha irreversibilità
Rs = 0.45 ÷ 0.55 irreversibilità incerta
Rs > 0.55 si ha reversibilità

Static irreversibility

Static irreversibility occurs when the rotation controlled by the output shaft is hindered; possible slow returns cannot be excluded should the load be subject to vibrations.

Rs < 0.45 provides irreversibility
Rs = 0.45 ÷ 0.55 irreversibility is uncertain
Rs > 0.55 reversibility is possible

Statische Selbsthemmung

Statische Selbsthemmung liegt vor, wenn die von Abtriebswelle gesteuerten Drehung gehindert wird. Langsamer Rücklauf ist möglich, falls die Last Schwingungen ausgesetzt wird.

Rs < 0.45 es liegt Selbsthemmung vor
Rs = 0.45 ÷ 0.55 ungewisse Selbsthemmung
Rs > 0.55 es liegt Reversibilität vor

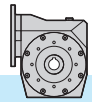

Irreversibilità dinamica

Condizione di arresto e quindi di sostegno del carico nel momento in cui cessa l'azione di comando. La condizione è più difficile da ottenere in quanto viene influenzata dal rendimento dinamico, dalla velocità di rotazione, da eventuali vibrazioni che il carico può generare e dalla direzione del movimento rispetto al carico.

Quest'ultima condizione è molto evidente nei sollevamenti: un carico in salita, cessando l'azione di comando, deve arrestarsi e quindi assumere velocità zero (rendimento statico) prima di invertire il moto e cadere per gravità.

Un carico in discesa tende invece a proseguire nel suo moto ostacolato, nella caduta, dal solo rendimento dinamico.

Rd < 0.45 si ha irreversibilità
Rd = 0.45 ÷ 0.55 irreversibilità incerta
Rd > 0.55 si ha reversibilità

Dynamic irreversibility

Dynamic irreversibility is characterized by stillstand and hold of the load when the drive stops. It is more difficult to achieve this condition because it is influenced by dynamic efficiency, speed of rotation and possible vibrations generated by the motion direction with regard to the load.

This last condition is much more evident during the lifting: if the drive stops during the lifting of the load this has to come to a speed equals to zero (static irreversibility) before the reversal of motion rotation and its drop for gravity.

On the contrary the load during its descent gets its motion obstructed by its dynamic efficiency.

Rd < 0.45 provides irreversibility
Rd = 0.45 ÷ 0.55 irreversibility is uncertain
Rd > 0.55 reversibility is possible

Dinamische Selbsthemmung

Stillstand und Stütze der Last beim Aussetzen der Steuerung. Diese Bedingung ist schwieriger zu erreichen, da sie vom dynamischen Wirkungsgrad, der Drehzahl und von der Last verursachten möglichen Vibrationen abhängig ist

Dieser letzte Fall kommt bei Hubanwendungen stark zu tragen. Wenn der Antrieb während dem Hub stoppt, muss die Last eine Geschwindigkeit von annähernd null erreichen (statische Irreversibilität), bevor die Rotation sich umkehrt und die Last durch die Gravitation nach unten fährt.

Dem entgegengesetzt bekommt die Last durch die Abwärtsbewegung Ihre dynamische Effizienz.

Rd < 0.45 es liegt Selbsthemmung vor
Rd = 0.45 ÷ 0.55 ungewisse Selbsthemmung
Rd > 0.55 es liegt Reversibilität vor

2.5 Gioco angolare

Gioco angolare standard

Misurato bloccando l'albero entrata, e ruotando l'albero uscita nelle due direzioni applicando la coppia strettamente necessaria a creare il contatto tra i denti degli ingranaggi, al massimo pari al 2% della coppia nominale (T_{2M}).

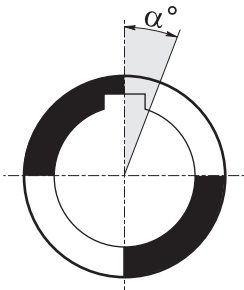

2.5 Backlash

Backlash

Angular backlash measured after having blocked the input shaft by rotating output shaft in both directions and applying the torque which is strictly necessary to create a contact between the teeth of the gears. The applied torque should be at most 2% of the max. torque (T_{2M}).

2.5 Winkelspiel

Winkelspiel

Nachdem die Antriebswelle blockiert worden ist, darf das Winkelspiel auf die Abtriebswelle bemessen werden. Dabei soll die Antriebswelle in beiden Richtungen gedreht werden und ein Drehmoment ausgeübt werden, das zur Entstehen eines Kontaktes zwischen den Zähnen genuegt. Das ausgeübte Drehmoment soll höchstens 2% des max. von Getrieben garantierten Drehmoment (T_{2M}) sein.

GHA					
i_n	30	40	50	63	75
	max	max	max	max	max
5	16'	13.5'	10.5'	10'	/
7.5	16'	13.5'	10.5'	10'	10'
10	16'	13.5'	10.5'	10'	10'
15	16'	13.5'	10.5'	10'	10'
20	14.5'	12'	9.5'	8.5'	8.5'
25	14.5'	12'	9.5'	8.5'	8.5'
30	14.5'	12'	8.5'	8.5'	8.5'
40	14.5'	12'	9.5'	8.5'	8.5'
50	14'	12'	9.5'	8.5'	8.5'
65	14'	12'	9'	8'	8'
80	13.5'	11.5'	9'	7.5'	7.5'
100	13'	11'	9'	7.5'	7.5'

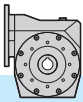

2.6 Carichi radiali

Carichi radiali Fr_2 e assiali Fa_2 sull'albero uscita [N]

Se il carico radiale sull'albero non è applicato a metà della sporgenza dell'albero, il valore del carico ammissibile deve essere valutato utilizzando la formula che si riferisce ad Fry_2 , in cui i valori di a , b e Fr_2 sono riportati nelle tabelle relative ai carichi radiali.

Nel caso di alberi bisporgenti il valore del carico applicabile a ciascuna estremità è uguale ai 2/3 del valore di tabella, purché i carichi applicati siano uguali di intensità e direzione ed agiscano nello stesso senso. Diversamente contattare il servizio tecnico.

2.6 Radial load

Fr_2 radial loads and Fa_2 axial loads on the output shaft [N]

Should the radial load affect the shaft not at the half-way point of its projection but at a different point, the value of the admissible load has to be calculated using the Fry_2 formula: a , b and Fr_2 values are reported in the radial load tables.

With regard to double-projecting shafts, the load applicable at each end is 2/3 of the value given in the table, on condition that the applied loads feature same intensity and direction and that they act in the same direction.

Otherwise please contact the technical department.

2.6 Radialbelastungen

Fr_2 Radialbelastungen und Fa_2 Axialbelastungen auf die Abtriebswelle [N]

Falls die Radialbelastungen nicht in dem Mittelpunkt der herausragenden Welle sondern in einem anderen Punkt wirken, soll die zulässige Belastung mit der Formel bezüglich Fry_2 kalkuliert werden: a , b und Fr_2 Werte sind aus der Tabelle der Radialbelastungen zu entnehmen.

Bei doppelseitigen Abtriebswellen ist die Belastung, die an jedem Ende anwendbar ist, 2/3 des in der Tabelle angegebenen Wertes unter der Bedingung, dass die Belastungen die selbe Stärke und Richtung aufweisen und dass sie in der selben Richtung wirken. Andernfalls muß mit dem technischen Büro Rücksprache gehalten werden.

I carichi radiali indicati nelle tabelle si intendono applicati a metà della sporgenza dell'albero e sono riferiti ai riduttori operanti con fattore di servizio 1.

The radial loads indicated in the chart are considered to be applied at the half-way point of the shaft projection, and refer to gear units operating with service factor 1.

Die Radialbelastungen, die in den Tabellen angegeben werden, gelten für Ansatzpunkte in der Mitte des herausragenden Wellenteils und für Getriebe mit Betriebsfaktor 1.

GHA											
$n_1=1400$ rpm		30		40		50		63		75	
i_n	n_2 [rpm]	a = 64.5 b = 47		a = 81.5 b = 58.5		a = 99 b = 70.5		a = 119.5 b = 90.5		a = 131 b = 97	
		Fr_2	Fa_2	Fr_2	Fa_2	Fr_2	Fa_2	Fr_2	Fa_2	Fr_2	Fa_2
5	280	600	120	750	150	900	180	1050	210	/	/
7.5	187	620	125	850	170	1050	210	1200	240	1500	300
10	140	680	140	950	190	1150	230	1350	270	1700	340
15	93	720	145	1000	200	1250	250	1500	300	1900	380
20	70	750	150	1100	220	1400	280	1650	330	2050	410
25	56	800	160	1200	240	1500	300	1850	370	2250	450
30	47	850	170	1250	250	1650	330	2000	400	2450	490
40	35	900	180	1350	270	1750	350	2150	430	2600	520
50	28	920	185	1450	290	1850	370	2300	460	2800	560
60	23	970	195	1550	310	2000	400	2500	500	3000	600
63	22	1000	200	1600	320	2100	420	2650	530	3200	640
80	17.5	1050	210	1700	340	2250	450	2800	560	3350	670
100	14	1100	220	1800	360	2350	470	2950	590	3550	710

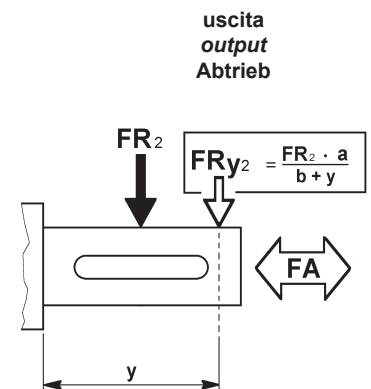

2.7 Senso di rotazione

2.7 Direction of rotation

2.7 Drehrichtung

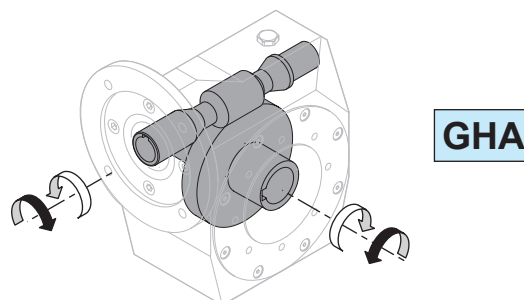

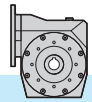

2.8 Lubrificazione

I riduttori a vite senza fine serie GHA sono forniti completi di lubrificante sintetico per uso alimentare: OLIO FUCHS CASSIDA FLUID 150.

Si raccomanda di precisare sempre, in fase di ordine, la posizione di montaggio desiderata.

Per ulteriori dettagli consultare pag. 17 paragrafo 1.6

2.8 Lubrication

The GHA series worm gearboxes are supplied complete with synthetic lubricant for food use: FUCHS CASSIDA FLUID 150 OIL.

It is recommended to always specify the desired assembly position when placing the order.

For further details, please see page 17 paragraph 1.6

2.8 Schmierung

Die Schneckengetriebe der Serie GHA werden mit synthetischem Lebensmittelöl FUCHS CASSIDA FLUID 150 geliefert.

Es wird empfohlen, bei der Bestellung immer die gewünschte Einbaulage anzugeben.

Für weitere Details siehe Seite 17, Absatz 1.6.

Posizioni di montaggio

Mounting positions

Einbaulagen

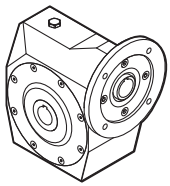

B3

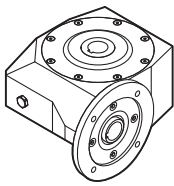

B6

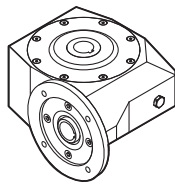

B7

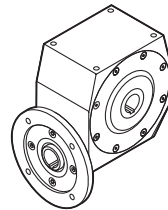

B8

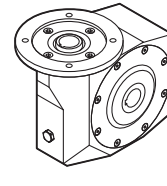

V5

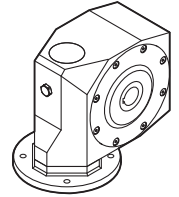

V6

E' presente un solo tappo di riempimento olio. *There is only one filling plug only.*

Es gibt nur eine Einfüllschraube.

		Q.tà olio / Oil quantity / Schmiermittelmenge [lt]				
		Posizione di montaggio / Mounting position / Einbaulage				
		B3	B6 - B7	B8	V5	V6
GHA	30	0.025	0.040	0.055	0.040	0.040
	40	0.040	0.075	0.100	0.065	0.085
	50	0.085	0.130	0.180	0.125	0.140
	63	0.180	0.260	0.360	0.240	0.290
	75	0.270	0.360	0.450	0.350	0.370

2.9 Posizione morsettiera

2.9 Terminal board position

2.9 Lage der Klemmenkaste

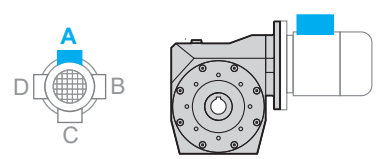
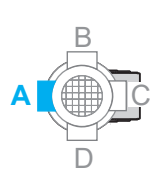
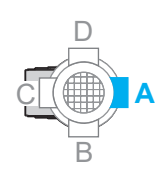
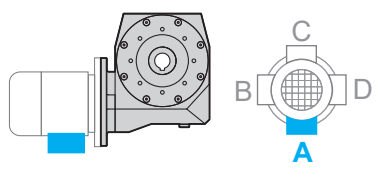
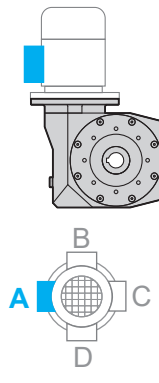
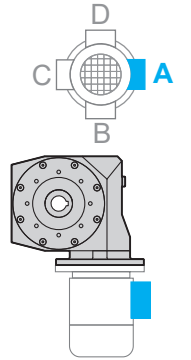
<p>B3</p> 	<p>B6</p> 	<p>B7</p> 
<p>B8</p> 	<p>V5</p> 	<p>V6</p> 

Specificare sempre in fase di ordinazione la posizione di montaggio e la forma costruttiva.

Mounting position always to be specified when ordering.

Bei der Bestellung immer die gewünschte Montageposition und Bauform angeben.

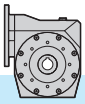

GHA... + MHA... PREMIUM

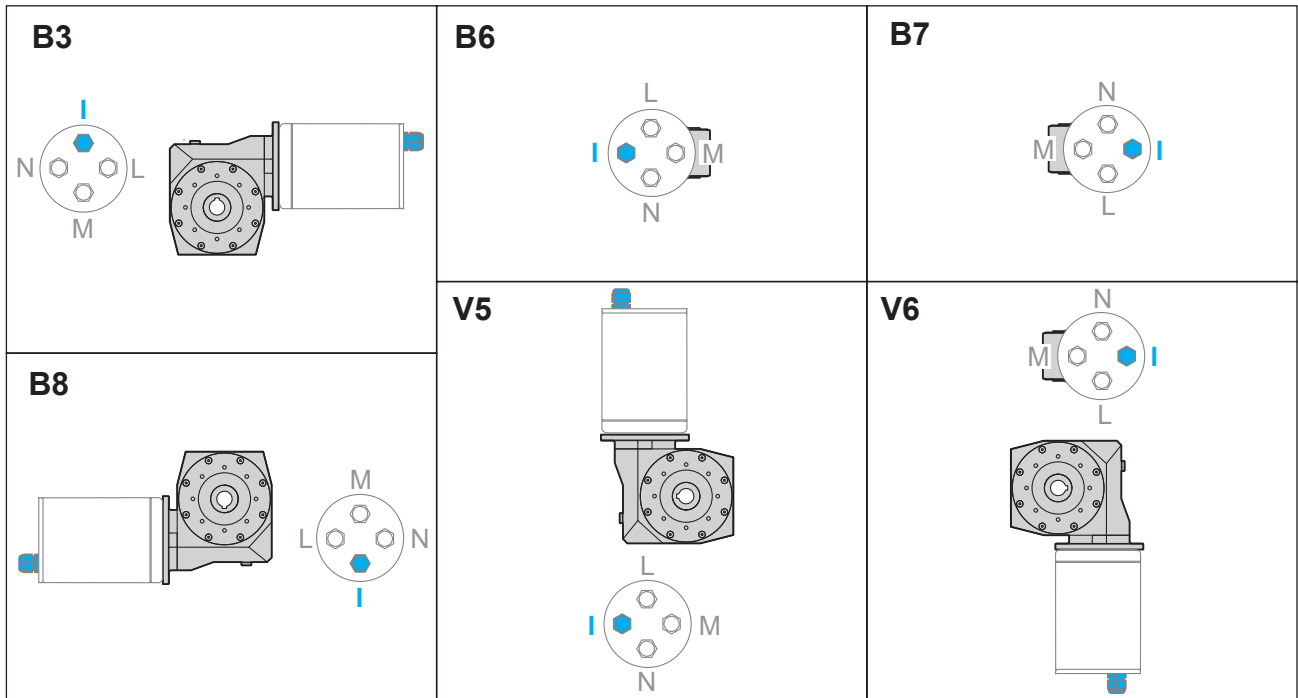

Specificare sempre in fase di ordinazione la posizione di montaggio e la forma costruttiva.

Mounting position always to be specified when ordering.

Bei der Bestellung immer die gewünschte Montageposition und Bauform angeben.

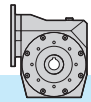

2.11 Dati tecnici

2.11 Technical data

2.11 Technische Daten

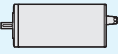
GHA 30	$n_1 = 1400$				MOTORI / MOTORS / ENGINE								
	i_n	n_2 [min ⁻¹]	Rd	P_{t0}	GHA CLASSIC				MHA PREMIUM				
					T_2 [Nm]	P_1 [kW]	Input IEC B14	FS'	T_2 [Nm]	P_1 [kW]	Input IEC B14		FS'
Kg 1.5	5	280	0.87	0.40	6.5	0.22	63	2.9	5.3	0.18	63	MHA 63 BS	3.6
	7.5	187	0.84	0.40	9	0.22		2.2	7.7	0.18			2.7
	10	140	0.82	0.40	12	0.22		1.8	10	0.18			2.2
	15	93	0.77	0.30	17	0.22		1.3	14	0.18			1.6
	20	70	0.72	0.20	18	0.18		1.1	18	0.18			1.1
	25	56	0.69	0.20	21	0.18		1.0	21	0.18			1.0
	30	47	0.66	0.20	18	0.13	1.1	17	0.13	1.2	MHA 63 AS		
	40	35	0.59	0.20	21	0.13	1.0	21	0.13	1.0			
	50	28	0.55	0.20	17	0.09	1.1	24	0.13	0.8			
	65	22	0.51	0.10	20	0.09	1.0	-	-	-		-	
80	18	0.48	0.10	16	0.06	1.0	-	-	-	-	-		
100	14	0.45	0.10	18	0.06	0.8	-	-	-	-	-		

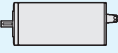
GHA 40	$n_1 = 1400$				MOTORI / MOTORS / ENGINE								
	i_n	n_2 [min ⁻¹]	Rd	P_{t0}	GHA CLASSIC				MHA PREMIUM				
					T_2 [Nm]	P_1 [kW]	Input IEC B14	FS'	T_2 [Nm]	P_1 [kW]	Input IEC B14		FS'
Kg 2.8	5	280	0.87	0.80	16.3	0.55	71	2.1	11	0.37	71	MHA 71 BS	3.1
	7.5	187	0.85	0.80	24	0.55		1.7	16	0.37			2.5
	10	140	0.83	0.70	31	0.55		1.3	21	0.37			2.0
	15	93	0.79	0.50	30	0.37		1.4	30	0.37			1.4
	20	70	0.76	0.50	38	0.37		1.0	38	0.37			1.1
	25	56	0.72	0.40	31	0.25		1.1	31	0.25			1.2
	30	47	0.68	0.40	35	0.25	1.2	35	0.25	1.2	MHA 71 AS		
	40	35	0.64	0.30	38	0.22	1.0	31	0.18	1.2			
	50	28	0.59	0.30	36	0.18	1.1	36	0.18	1.1			
	65	22	0.54	0.20	31	0.13	1.1	30	0.13	1.2			
80	18	0.52	0.20	35	0.13	0.9	36	0.13	0.9	MHA 63 AS			
100	14	0.49	0.20	43	0.13	0.6	43	0.13	0.6				

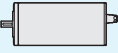
GHA 50	$n_1 = 1400$				MOTORI / MOTORS / ENGINE								
	i_n	n_2 [min ⁻¹]	Rd	P_{t0}	GHA CLASSIC				MHA PREMIUM				
					T_2 [Nm]	P_1 [kW]	Input IEC B14	FS'	T_2 [Nm]	P_1 [kW]	Input IEC B14		FS'
Kg 4.5	5	280	0.87	1.2	26.7	0.9	80	2.3	22	0.75	80	MHA 80 BS	2.8
	7.5	187	0.86	1.2	40	0.9		1.8	33	0.75			2.1
	10	140	0.84	1.0	52	0.9		1.4	43	0.75			1.7
	15	93	0.80	0.80	74	0.9		1.0	62	0.75			1.2
	20	70	0.78	0.70	58	0.55		1.3	53	0.5			1.4
	25	56	0.74	0.60	47	0.37		1.4	63	0.5			1.0
	30	47	0.71	0.60	53	0.37	1.2	53	0.37	1.2	MHA 80 AS		
	40	35	0.67	0.50	68	0.37	1.0	68	0.37	1.0			
	50	28	0.62	0.40	53	0.25	1.3	53	0.25	1.3			
	65	22	0.58	0.40	64	0.25	1.0	63	0.25	1.0			
80	18	0.54	0.40	71	0.25	0.8	52	0.18	1.1	MHA 63 BM			
100	14	0.51	0.30	86	0.25	0.6	45	0.13	1.2				

* **ATTENZIONE:** la coppia massima utilizzabile [T_{2M}] deve essere calcolata utilizzando il fattore di servizio: $T_{2M} = T_2 \times FS'$

* **WARNING:** Maximum allowable torque [T_{2M}] must be calculated using the following service factor: $T_{2M} = T_2 \times FS'$

* **ACHTUNG:** das max. anwendbare Drehmoment [T_{2M}] muss mit folgendem Betriebsfaktor berechnet werden: $T_{2M} = T_2 \times FS'$

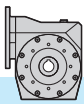

2.11 Dati tecnici

2.11 Technical data

2.11 Technische Daten

GHA 63	$n_1 = 1400$				MOTORI / MOTORS / ENGINE								
	i_n	n_2 [min ⁻¹]	Rd	P_{t0}	GHA CLASSIC				MHA PREMIUM				
					T_2 [Nm]	P_1 [kW]	Input IEC B14	FS'	T_2 [Nm]	P_1 [kW]	Input IEC B14		FS'
Kg 7.8	5	280	0.88	1.8	54	1.8	90	2.0	45	1.5	90	MHA 90 BS	2.5
	7.5	187	0.87	1.8	80	1.8		1.5	67	1.5			1.8
	10	140	0.85	1.6	105	1.8		1.2	87	1.5			1.5
	15	93	0.81	1.2	125	1.5		1.1	125	1.5			1.1
	20	70	0.80	1.2	120	1.1		1.2	120	1.1			1.2
	25	56	0.77	1.0	118	0.9	1.0	98	0.75	1.2	MHA 90 AS	1.2	
	30	47	0.73	0.90	134	0.9	1.1	111	0.75	1.3			
	40	35	0.69	0.80	142	0.75	1.1	141	0.75	1.1	MHA 80 BS	1.1	
	50	28	0.65	0.70	122	0.55	1.0	111	0.5	1.1			
	65	22	0.61	0.60	145	0.55	0.8	98	0.37	1.2	MHA 80 AS	1.2	
80	18	0.58	0.60	169	0.55	0.6	113	0.37	1.0				
100	14	0.53	0.50	198	0.55	0.5	90	0.25	1.1	MHA 71 BM	1.0		
											MHA 71 AM	1.1	

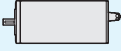
GHA 75	$n_1 = 1400$				MOTORI / MOTORS / ENGINE									
	i_n	n_2 [min ⁻¹]	Rd	P_{t0}	GHA CLASSIC				MHA PREMIUM					
					T_2 [Nm]	P_1 [kW]	Input IEC B14	FS'	T_2 [Nm]	P_1 [kW]	Input IEC B14		FS'	
Kg 12.8	7.5	187	0.87	2.5	80	1.8	90	2.7	67	1.5	90	MHA 90 BS	2.7	
	10	140	0.86	2.3	106	1.8		1.8	88	1.5			2.2	
	15	93	0.83	1.9	153	1.8		1.3	128	1.5			1.6	
	20	70	0.81	1.7	199	1.8		1.1	166	1.5			1.3	
	25	56	0.78	1.5	200	1.5		1.0	200	1.5			1.0	
	30	47	0.74	1.2	167	1.1		1.3	165	1.1		1.4	MHA 90 AS	1.4
	40	35	0.71	1.1	213	1.1		1.1	213	1.1		1.1		
	50	28	0.67	1.0	251	1.1		0.8	171	0.75		1.2	MHA 80 BM	1.2
	65	22	0.63	0.90	300	1.1		0.6	137	0.5		1.4	MHA 80 AM	1.4
	80	18	0.60	0.80	350	1.1		0.5	159	0.5		1.1		
100	14	0.56	0.70	420	1.1	0.4	191	0.5	0.9					

* **ATTENZIONE:** la coppia massima utilizzabile $[T_{2M}]$ deve essere calcolata utilizzando il fattore di servizio: $T_{2M} = T_2 \times FS'$

* **WARNING:** Maximum allowable torque $[T_{2M}]$ must be calculated using the following service factor: $T_{2M} = T_2 \times FS'$

* **ACHTUNG:** das max. anwendbare Drehmoment $[T_{2M}]$ muss mit folgendem Betriebsfaktor berechnet werden: $T_{2M} = T_2 \times FS'$

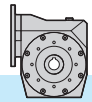



2.12 **Momenti d'inerzia** [Kg·cm²]
(riferiti all'albero veloce in entrata)

2.12 **Moments of inertia** [Kg·cm²]
(referred to input shaft)

2.12 **Trägheitsmoment** [Kg·cm²]
(bez. Antriebswelle)

GHA 30	i _n		
		B14	
		IEC 56	IEC 63
5	0.130	0.127	
7.5	0.112	0.109	
10	0.103	0.100	
15	0.097	0.094	
20	0.095	0.092	
25	0.094	0.091	
30	0.093	0.090	
40	0.093	0.090	
50	0.092	0.089	
65	0.079	-	
80	0.079	-	
100	0.078	-	

GHA 63	i _n		
		B14	
		IEC 80	IEC 90
5	2.431	2.671	
7.5	1.949	2.269	
10	1.744	2.063	
15	1.597	1.916	
20	1.545	1.864	
25	1.514	1.833	
30	1.508	1.828	
40	1.495	-	
50	1.488	-	
65	1.484	-	
80	1.482	-	
100	1.481	-	

GHA 40	i _n		
		B14	
		IEC 63	IEC 71
5	0.391	0.463	
7.5	0.321	0.356	
10	0.272	0.347	
15	0.266	0.340	
20	0.263	0.338	
25	0.262	0.337	
30	0.262	0.337	
40	0.261	0.336	
50	0.261	-	
65	0.261	-	
80	0.261	-	
100	0.261	-	

GHA 75	i _n		
		B14	
		IEC 90	
7.5	3.712		
10	3.234		
15	2.893		
20	2.774		
25	2.709		
30	2.689		
40	2.659		
50	2.642		
65	2.633		
80	2.629		
100	2.626		

GHA 50	i _n		
		B14	
		IEC 71	IEC 80
5	0.922	1.046	
7.5	0.684	0.935	
10	0.602	0.853	
15	0.543	0.794	
20	0.523	0.774	
25	0.513	0.764	
30	0.508	0.759	
40	0.503	0.755	
50	0.501	-	
65	0.499	-	
80	0.498	-	
100	0.498	-	

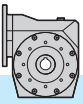

2.13 Dimensioni

2.13 Dimensions

2.13 Abmessungen

GHA.. PP

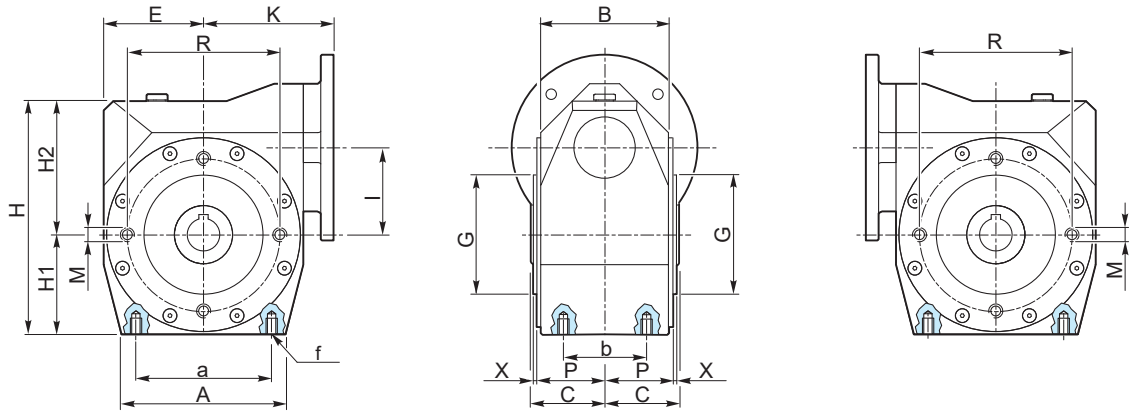

GHA.. CC

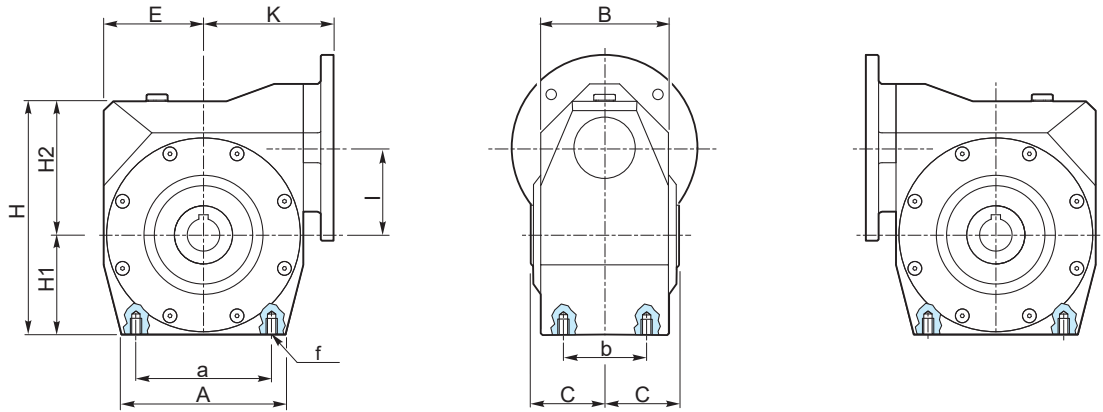

GHA.. PD

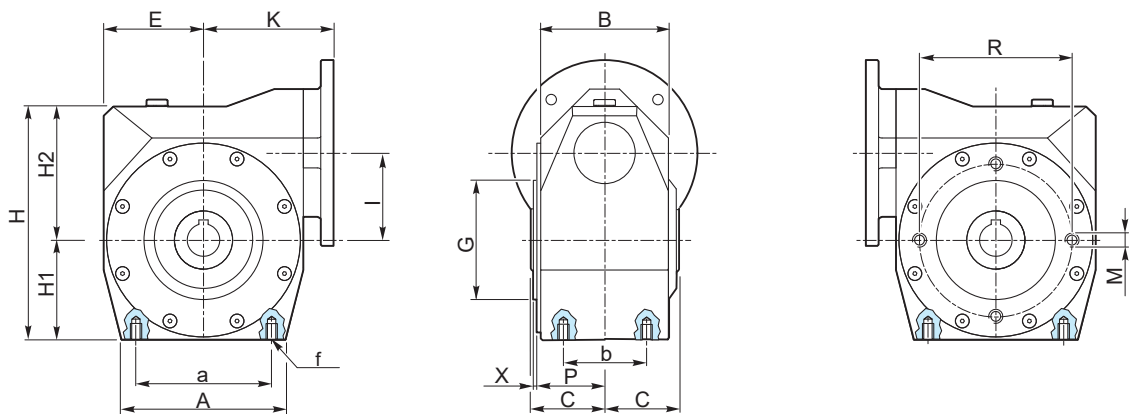

GHA.. PS

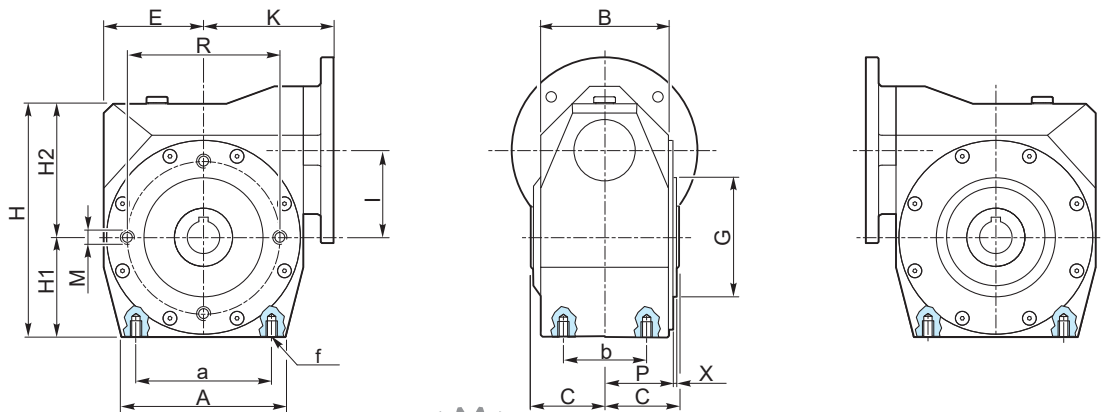

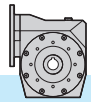

2.13 Dimensioni

2.13 Dimensions

2.13 Abmessungen

Flangia pendolare / Shaft-mounted flange / Aufsteckflansch

30

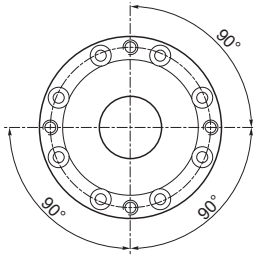

4 Fori / Holes / Bohrungen

40 - 50

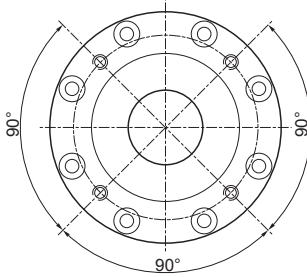

4 Fori / Holes / Bohrungen

63 - 75 - 89

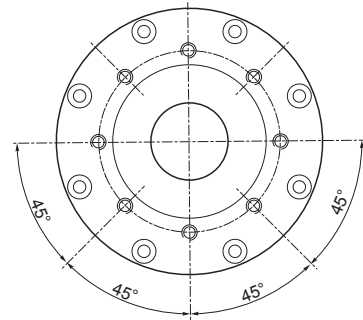

8 Fori / Holes / Bohrungen

Albero uscita cavo
Output hollow shaft
Abtriebshohlwelle

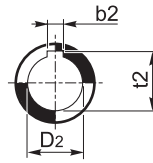

GHA	A	a	B	b	b ₂	C	D ₂ H8	E	f	G h8	H	H ₁	H ₂
30	66	54	56	44	5	31.5	14	40	M6 x 9	55	93	40	53
40	85	70	71	60	6	39	18	50	M6 x 11	60	116	50	66
50	95	80	84	70	8	46	25	60	M8 x 12	70	142	60	82
63	118	100	101	85	8	56	25	72	M8 x 16	80	173	72	101
75	142	120	110	90	8	60	28	86	M10 x 16	95	201	86	115

GHA	I	K	M	P	R	t ₂	X	kg
30	31.5	57	M6x8	29	65	16.3	1.5	1.5
40	40	75	M6X10	36.5	75	20.8	1.5	2.8
50	50	82	M8x10	43.5	85	28.3	1.5	4.5
63	63	96.8	M8x14	53	95	28.3	2	7.8
75	75	112	M8x14	57	115	31.3	2	12.8

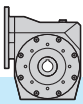

GHA.. + MHA PREMIUM

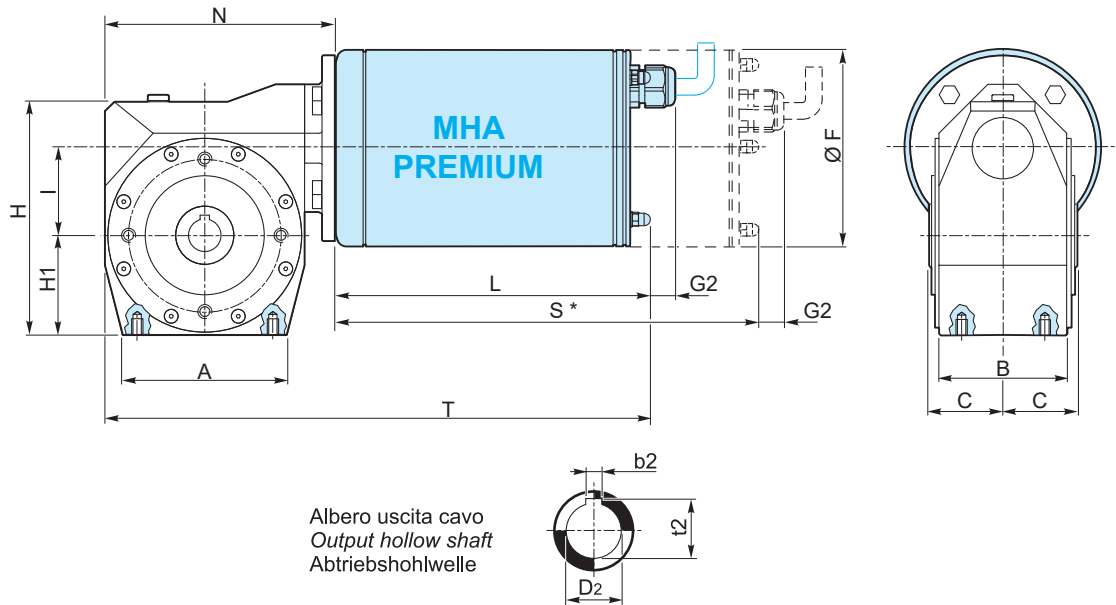

GHA	A	B	b ₂	C	D ₂ H8	H	H ₁	I	t ₂	N
30	66	56	5	31.5	14	93	40	31.5	16.3	97
40	85	71	6	39	18	116	50	40	20.8	125
50	95	85	8	46	25	142	60	50	28.3	148
63	118	103	8	56	25	173	72	63	28.3	168.8
75	142	112	8	60	28	201	86	75	31.3	198

GHA... + MHA... PREMIUM											
GHA	GHA 30	GHA 40		GHA 50			GHA 63		GHA 75		
IEC B14	63	63	71	71		80	80		90		
MHA	MHA63		MHA71	MHA63	MHA71	MHA80	MHA71	MHA80	MHA90	MHA80	MHA90
F	Ø118		Ø134	Ø118	Ø134	Ø150	Ø134	Ø150	Ø190	Ø150	Ø190
L	235		246	235	246	271	246	271	339	271	339
G2	16 (con pressacavo standard / with standard cable gland / mit Standard-Klemmenkasten)										
T	332	360	371	383	394	419	414.8	439.8	507.8	469	537
	10.3	11.6	15.8	13.3	17.5	22.5	20.8	25.8	32.8	30.8	37.8
	0.13 kW	0.13 kW	0.25 kW	0.13 kW	0.25 kW	0.50 kW	0.25 kW	0.50 kW	1.1 kW	0.50 kW	1.1 kW
	11	12.3	17.3	14.0	19.0	23.5	22.3	26.8	39.8	31.8	44.8
	0.18 kW	0.18 kW	0.37 kW	0.18 kW	0.37 kW	0.75 kW	0.37 kW	0.75 kW	1.5 kW	0.75 kW	1.5 kW

*S: quota valida solo per le versioni a richiesta (freno, encodeer, ecc.).

*S: value valid only for the versions on request (brake, encodeer, ecc.).

*S: Wert gilt nur für die Versionen auf Anfrage (Bremse, Encodeer, ecc.).

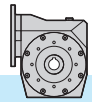

2.13 Dimensioni

2.13 Dimensions

2.13 Abmessungen

Flangia entrata / Input flange / Antriebsflansch

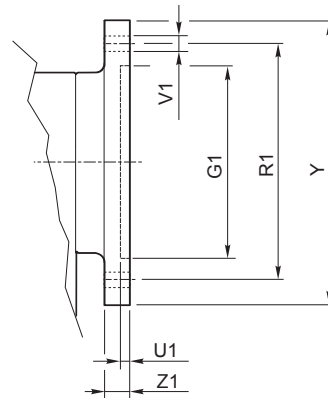
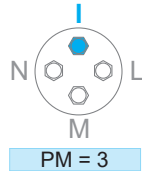
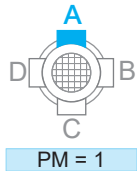

GHA	IEC	G ₁	R ₁	U ₁	V ₁		Y	Z ₁	Diametro fori PAM / Holes diameter IEC / IEC Durchmesser												
					∅				5	7.5	10	15	20	25	30	40	50	65	80	100	
30	56 B14	50	65	3.5	6	4	80	8	9	9	9	9	9	9	9	9	9	9	9	9	9
	63 B14	60	75	4	6	4	90	8	11	11	11	11	11	11	11	11	11	11	/	/	/
40	63 B14	60	75	3.5	6	4	90	8	11	11	11	11	11	11	11	11	11	11	11	11	11
	71 B14	70	85	3.5	7	4	105	8	14	14	14	14	14	14	14	14	14	/	/	/	/
50	71 B14	70	85	3.5	7	4	105	8	14	14	14	14	14	14	14	14	14	14	14	14	14
	80 B14	80	100	4	7	4	120	10	19	19	19	19	19	19	19	19	19	/	/	/	/
63	80 B14	80	100	4	7	4	120	10	19	19	19	19	19	19	19	19	19	19	19	19	19
	90 B14	95	115	4	8.5	4	140	10	24	24	24	24	24	24	24	24	/	/	/	/	/
75	90 B14	95	115	4	9	4	140	11	/	24	24	24	24	24	24	24	24	24	24	24	24

N.B.: Il montaggio STD di P_M=1. Nel caso di motore MHA PREMIUM, montaggio STD di P_M=3.

N.B.: STD mounting of P_M=1. In the case of the MHA PREMIUM motor, STD assembly of P_M=3.

ANMERKUNG: STD Montage von P_M=1. Bei Motor MHA PREMIUM, STD-Montage von P_M=3.

2.14 Accessori (braccio di reazione)

2.14 Accessories (Torque arm)

2.14 Zubehör (Drehmomentstütze)

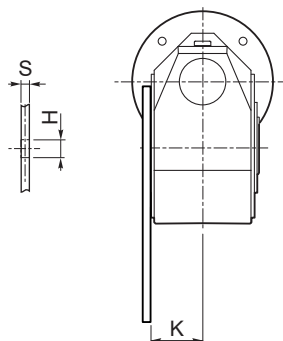
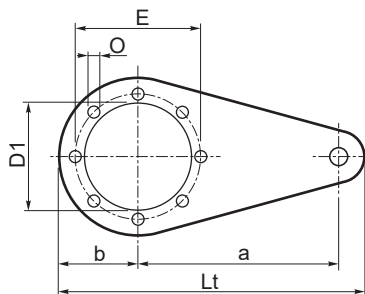

GHA	a	b	D ₁	E	H	K	L _t	O	S
30	85	37	55	65	8	29	138	6.5 n°4	5
40	100	47	60	75	10	36.5	167	7 n°4	5
50	100	57.5	70	85	10	43.5	179	9 n°4	5
63	150	55	80	95	10	53	227	9 n°8	6
75	200	67	95	115	20	57	299	9 n°8	6

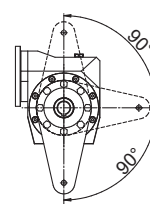

30 - 40 - 50

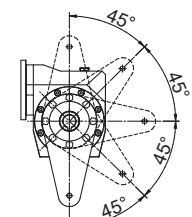

63 - 75 - 89

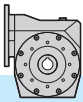

2.15 Lista parti di ricambio

2.15 Spare parts list

2.15 Ersatzteilliste

In fase di ordine delle parti di ricambio, specificare sempre n° particolare (vedi disegno esploso), data (1), n° codice (2) e n° variante (3). (Vedi targhetta).

When ordering please specify the spare part number (see exploded view) as well as the date (1), the article number (2) and the variant number (3) (see plate)

Bei der Bestellung von Ersatzteilen sind Ersatzteilnummer (s. Explosionszeichnung), Datum (1), Artikelnummer (2) und Variantennummer (3) anzugeben. (s. Schild)

CODICE: distinta base
 CODE: base list
 ART.-Nr.: Basisstückliste

TIPO: descrizione
 TYPE: description
 TYP: Bezeichnung

RAP: rapporto di riduzione
 RATIO: reduction ratio
 ÜBERS: Untersetzungsverhältnis

VARIANTE: codice alfanumerico
 MODEL: alphanumeric code
 VARIANTE: alphanumerische Nummer

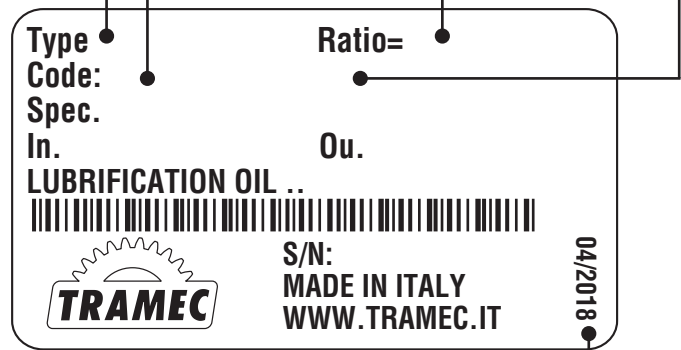

DATA: mese/anno
 DATE: month/year
 DATUM: Monat/Jahr

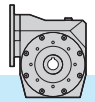

GHA

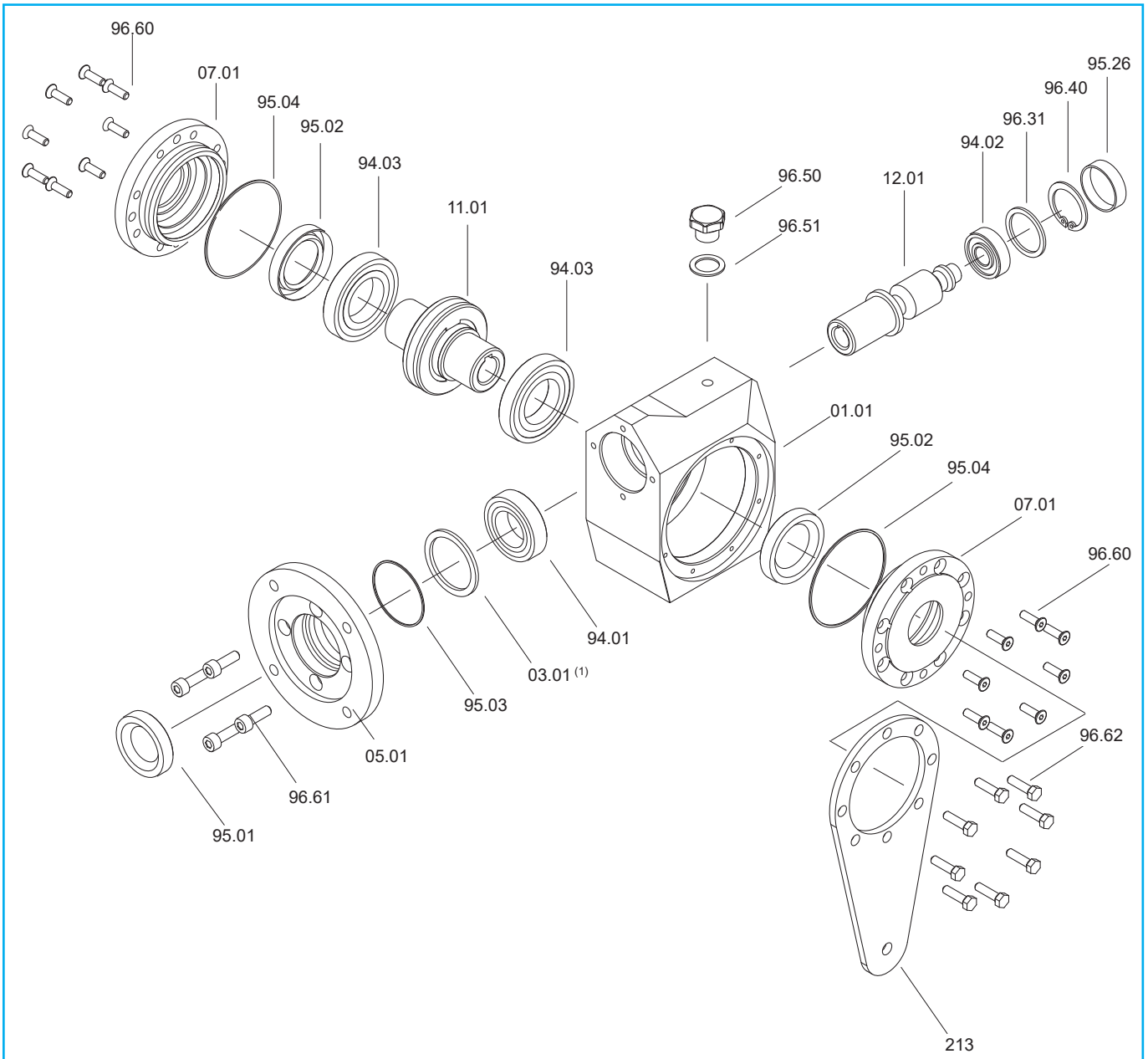

GHA	IEC	Cuscinetti / Bearings / Lager			Anelli di tenuta / Oilseals Öldichtungen		OR		Cappellotto / Closed oil seal Geschlossene Öldichtung
		94.01	94.02	94.03	95.01	95.02	95.03	95.04	95.26
30	56	61904 (20x37x9)	6000 (10x26x8)	16005 (25x47x8)	20/35/7	25/40/7	33x1.2	50x1.5	ø 26x7
	63				25/47/7	30/47/7			
40	63	6204 (20x47x14)	6201 (12x32x10)	16006 (30x55x9)	20/47/7	30/47/7	43x1.5	65x2	ø 32x7
	71	6005 (25x47x12)			25/47/7				
50	71	6005 (25x47x12)	6203 (17x40x12)	16008 (40x68x9)	25/47/7	40/62/8	50x1.5	82x2	ø 40x7
	80	6006 (30x55x13)			30/47/7				
63	80	6206 (30x62x16)	6204 C3 (20x47x14)	16008 (40x68x9)	30/62/7	40/62/8	56x1.5	102x2.5	ø 47x7
	90	6007 (35x62x14)			35/62/7				
75	90	6007 (35x62x14)	6205 C3 (25x52x15)	16010 (50x80x10)	35/62/7	50/72/8	60x3	123x3	ø 52x7

(1) Solo per GHA 63 PAM90 e 75 PAM 90 e 100 / Only for GHA 63 PAM 90 and 75 PAM 90 and 100 / Nur für GHA 63 PAM 90, 75 PAM 90 und 100

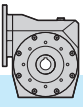

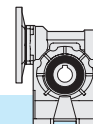

3.0 RIDUTTORE A VITE SENZA FINE SERIE GK GK WORM GEARBOXES SCHNECKENGETRIEBE GK

3.1	Caratteristiche	<i>Characteristics</i>	Merkmale	40
3.2	Designazione	<i>Designation</i>	Bezeichnung	41
3.3	Rendimento	<i>Efficiency</i>	Wirkungsgrad	42
3.4	Irreversibilità	<i>Irreversibility</i>	Selbsthemmung	42
3.5	Gioco angolare	<i>Backlash</i>	Winkelspiel	43
3.6	Carichi radiali	<i>Radial load</i>	Radialbelastungen	44
3.7	Senso di rotazione	<i>Direction of rotation</i>	Drehrichtung	44
3.8	Lubrificazione e posizioni di montaggio	<i>Lubrication and mounting position</i>	Schmierung und Einbaulage	45
3.9	Posizione morsettiera	<i>Terminal board position</i>	Lage des Klemmenbrett	45
3.10	Dati tecnici	<i>Technical data</i>	Technische Daten	46
3.11	Momenti d'inerzia	<i>Moments of inertia</i>	Trägheitsmoment	52
3.12	Dimensioni	<i>Dimensions</i>	Abmessungen	45
3.13	Entrata supplementare	<i>Additional input</i>	Zusatzantrieb	56
3.14	Accessori	<i>Accessories</i>	Zubehör	56
3.15	Lista parti di ricambio	<i>Spare parts list</i>	Ersatzteilliste	56

GHA - CLASSIC

La serie CLASSIC costituisce la serie standard all'interno della gamma di riduttori GHA.

Le speciali caratteristiche NANOTECHNOLOGICHE del rivestimento della carcassa e il suo design esterno, rendono i riduttori di questa serie particolarmente adatti per le applicazioni in ambienti ALIMENTARE e FARMACEUTICO.

Nonostante i riduttori delle serie GHA CLASSIC siano certificati come dispositivi idonei per l'utilizzo su macchine alimentari e dunque per applicazioni che operano in impianti di produzione e di manipolazione degli alimenti, essi non sono certificati per l'utilizzo a contatto con gli alimenti.

GHA - CLASSIC

The CLASSIC series is the standard series within the range of GHA gearboxes.

The special NANOTECHNOLOGICAL properties of the case coating and its external construction, certified by HACCP, make the gearboxes of this series particularly suitable for applications in FOOD and PHARMACEUTICAL environments.

Although the GHA CLASSIC series reducers are certified as suitable devices for use on food processing machines and therefore for applications that operate in food production and handling plants, they are not certified for use in contact with food.

GHA - CLASSIC

Die Serie CLASSIC ist die Standardbaureihe innerhalb der Produktpalette der GHA-behandelten Getriebe.

Durch die spezielle NANOTECHNOLOGISCHE Eigenschaften der Gehäusebeschichtung und das Design des Gehäuses (zertifiziert durch HACCP), sind die Getriebe dieser Serie besonders geeignet für den Einsatz in LEBENSMITTEL- und PHARMAZEUTISCHER Umgebung.

Obwohl die Getriebe der Baureihe GHA CLASSIC als Geräte zertifiziert sind, die für den Einsatz in Lebensmittelmaschinen und damit für Anwendungen in Anlagen zur Produktion und Handhabung von Lebensmitteln geeignet sind, sind sie nicht für den Einsatz in Kontakt mit Lebensmitteln zugelassen.

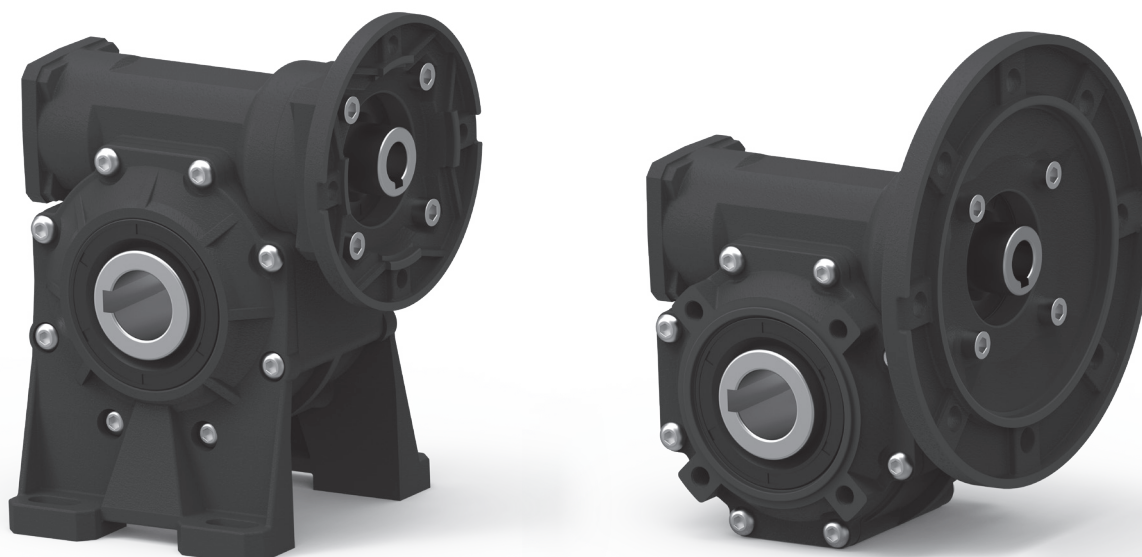

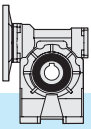

3.1 Caratteristiche

- I riduttori della serie a vite senza fine GK si presentano estremamente leggeri grazie alla forma compatta della carcassa per tutte le grandezze.
- La carcassa e le flange in lega di alluminio pressofusa sono sabbiata e trattate con tecnologia G.H.A..
- La serie presenta una svariata possibilità di versioni, con e senza piedi, che la rendono più versatile nell'impiego in ogni tipologia di applicazione.
- La serie GK è disponibile esclusivamente nella versione predisposta per attacco motore (PAM) e non con albero entrata maschio.
- La vite senza fine è in acciaio legato cementato-temprato ed è rettificata.
- La corona ha il mozzo in acciaio INOX AISI 316 e l'anello dentato in bronzo GCuSn12.
- Provvisti di albero cavo INOX AISI 316, bulloneria INOX, tenute con materiale certificato FDA e lubrificanti per l'industria alimentare (categoria di certificazione NSF H1).
- Per applicazioni nel settore marino (M) non si utilizzano lubrificanti NSF H1 ed anelli di tenuta in materiale certificato FDA.
- Viene fornito l'albero uscita cavo di serie ed esiste un'ampia disponibilità di accessori: seconda entrata (non in acciaio INOX), flangia uscita e braccio di reazione (in lega di alluminio con trattamento G.H.A. e montato con viti in acciaio INOX)

3.1 Characteristics

- *The GK worm gear series reducers are extremely lightweight thanks to the compact shape of the casing for all sizes.*
- *The casing and flanges in die-cast aluminium alloy are sandblasted and treated with G.H.A technology.*
- *The series features a wide range of versions, with and without feet, which make it more versatile for use in all types of applications.*
- *The GK series is only available in the version designed for motor coupling (PAM) and not with a male input shaft.*
- *The worm gear is made of cemented-tempered alloy steel and is ground.*
- *The crown wheel features an AISI 316 stainless steel hub and a GCuSn12 bronze toothed ring.*
- *Equipped with an AISI 316 stainless steel hollow shaft, seals made of FDA-certified material and lubricants for the food industry (NSF H1 certification category).*
- *For applications in the marine sector (M), NSF H1 lubricants and FDA-certified sealing rings are not used.*
- *The hollow output shaft is supplied as standard and there is a wide range of accessories available: second inlet (not in stainless steel), outlet flange and reaction arm (in aluminium alloy with G.H.A treatment and mounted with stainless steel screws)*

3.1 Merkmale

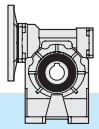

- Die Schneckengetriebe der Serie GK präsentieren sich in allen Baugrößen dank ihrer kompakten Gehäuseform als extrem leicht.
- Das Gehäuse und die Flansche aus Aluminiumdruckgusslegierung sind sandgestrahlt und mit G.H.A.-Technologie hergestellt.
- Die Serie verfügt über ein breites Angebot an Versionen, mit und ohne FüÙe, dank der sie vielseitiger in jeder Art von Anwendung einsetzbar ist.
- Die Serie GK ist ausschließlich in der Version mit Vorrüstung für den Motorschluss (PAM) und nicht mit Eingangswelle mit Außengewinde erhältlich.
- Die Schneckenwelle besteht aus einsatzgehärtetem, abgeschrecktem und daraufhin geschliffenem Legierungsstahl.
- Das Schneckenrad besteht aus einer Nabe aus Edelstahl AISI 316 und einer Bronze- Verzahnung GCuSn12.
- Ausgestattet mit einer Hohlwelle aus Edelstahl AISI 316, Edelstahlschrauben, Dichtungen aus FDA-zertifiziertem Material und Schmierstoffen für die Lebensmittelindustrie (Zertifizierungskategorie NSF H1).
- Für Anwendungen im Schifffahrtsbereich werden keine NSF H1-Schmierstoffe und Dichtungsringe aus FDA-zertifiziertem Material verwendet.
- Die hohle Abtriebswelle wird standardmäßig geliefert und es gibt eine große Auswahl an Zubehör: zweiter Eingang (nicht aus Edelstahl), Abtriebsflansch und Reaktionsarm (aus Aluminiumlegierung mit G.H.A.-Behandlung und mit Edelstahlschrauben montiert).



3.2 Designazione

3.2 Designation

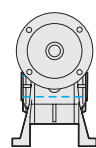
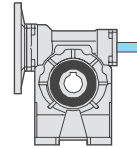
3.2 Bezeichnung

Riduttore Gearbox Getriebe	Tipo entrata Input type Antriebsart	Grandezza Size Größe	Versione Version Ausführung	Rapporto rid. Ratio Untersetzung	Predispos. att. mot. Motor coupling Motoranschluss	Posizione di mont. Mounting position Einbaulage	Albero uscita cavo Hollow output shaft Abtriebshohlwelle	Seconda entrata Additional input Zusatzantrieb	Braccio di reazione Torque arm Drehmomentstütze	Campo di applicazione Field of application Anwendungsbereich
GK	C	50	F1S	10	P.A.M	B3	H25	SeA	BR	A
Riduttore a vite senza fine Wormgearbox Schneckengetriebe		30 40 50 63 75 89	A1-A2 B1-B2 V1-V2 P F1S-F2S F3S F1D-F2D F3D	5 7.5 10 15 20 25 30 40 50 65 80 100	56 63 71 80 90 100 112	B3 B6 B7 B8 V5 V6	 H..	 SeA	 BR	A Alimentare e Farmaceutico Food and Pharmaceutical Lebensmittel- und Pharmaindustrie M * Marino Marine Schifffahrt

*: a richiesta

*: on request

*: auf Anfrage

Versioni

Versions

Ausführungen

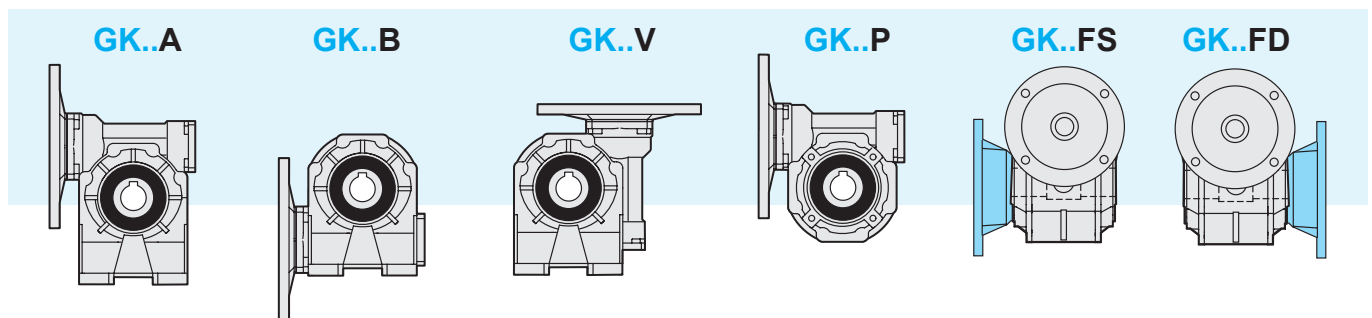

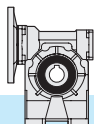

3.3 Rendimento

Rd - È il rendimento dinamico, definito come rapporto tra la potenza in uscita P_2 e quella in entrata P_1 . Dipende principalmente dalla velocità di strisciamento, dal tipo di lubrificante e dall'angolo d'elica. I valori indicati nelle tabelle sono validi se si applica la corrispondente coppia in uscita. In fase di rodaggio, circa le prime 300 ore di funzionamento sotto carico, il valore deve essere considerato inferiore del 30% rispetto a quello indicato in tabella.

Rs - È il rendimento statico che si ha al momento dell'avviamento del riduttore e varia in base al rapporto di riduzione. Risulta importante, per una corretta valutazione del riduttore da impiegare, nelle applicazioni in cui non si raggiungono mai le condizioni di regime come nei funzionamenti intermittenti. Analogamente al caso dinamico, anche il rendimento statico durante il rodaggio risulta inferiore del 30% rispetto al valore indicato in tabella.

3.3 Efficiency

Rd - dynamic efficiency, defined as the ratio between P_2 output power and P_1 input power. It mainly depends on the slipping speed, the type of lubricant and the lead angle. The values reported in the table are valid when the corresponding output torque is applied. During the first 300 operating hours under load, the value to be considered is 30% lower than that reported in the table.

Rs - static efficiency at gearbox start-up; it changes depending on the reduction ratio. Rs value is important for selecting the right gearbox for applications where a steady state is never achieved, as for intermittent duty applications. Same as dynamic efficiency, static efficiency too during the running-in period will be 30% lower than the value reported in the table.

3.3 Wirkungsgrad

Rd - dynamischer Wirkungsgrad, ist das Verhältnis zwischen P_2 Abtriebsleistung und P_1 Antriebsleistung. Rd Wert wird durch Gleitgeschwindigkeit, Art des Schmiermittels und Steigungswinkel beeinflusst. Die Tabellen zeigen die Werte die gültig sind wenn das entsprechende Abtriebsdrehmoment gegeben ist. Während der Einlaufzeit in den ersten 300 Betriebsstunden unter Belastung, ist dieser Wert 30% niedriger als der in der Leistungstabelle angegebenen Wert.

Rs - statischer Wirkungsgrad beim Getriebebestart und in Abhängigkeit zur Unterersetzung. Der Wert Rs ist wichtig für die Auswahl des richtigen Getriebes für Anwendungen wo ein stetiger Betrieb nicht auftritt, wie bei Anwendungen mit Aussetzbetrieb. Der statischer Wirkungsgrad auch während der Einlaufzeit wird 30% niedriger als der in der Tabelle angegebenen Wert.

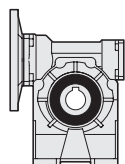

GK	Rs											
	5	7.5	10	15	20	25	30	40	50	65	80	100
30	0.70	0.67	0.62	0.55	0.47	0.43	0.39	0.30	0.27	0.25	0.22	0.21
40	0.69	0.67	0.63	0.55	0.52	0.45	0.40	0.35	0.29	0.26	0.25	0.23
50	0.69	0.68	0.65	0.58	0.53	0.47	0.41	0.37	0.32	0.28	0.25	0.23
63	0.70	0.68	0.65	0.57	0.55	0.50	0.47	0.38	0.33	0.29	0.28	0.23
75	/	0.68	0.65	0.58	0.55	0.51	0.43	0.39	0.35	0.31	0.28	0.24
89	/	0.68	0.65	0.58	0.55	0.52	0.45	0.39	0.36	0.32	0.29	0.25

3.4 Irreversibilità

Nelle applicazioni dove è necessario evitare la trasmissione del moto retrogrado o sostenere il carico, in assenza di alimentazione elettrica, è consigliabile adottare freni esterni.

Nei riduttori a vite senza fine emerge questa caratteristica naturale, denominata grado di irreversibilità, che cresce con l'aumentare del rapporto di riduzione in quanto strettamente legata al relativo rendimento.

Per ottenere alti gradi di irreversibilità occorre quindi adottare i rapporti di riduzione più elevati, senza dimenticare che, il rendimento, tende a crescere durante le prime 500 ore di funzionamento per poi stabilizzarsi sui valori riportati a catalogo.

3.4 Irreversibility

The use of external brakes is advised in case of applications where backwards motion must be hindered and the load must be held should the feed be cut off.

Some worm gearboxes feature natural irreversibility. The higher the ratio, the higher is the irreversibility, since it is strictly dependent on the relative efficiency.

In order to achieve high irreversibility it is therefore necessary to select higher efficiency reduction ratios not to forget that the efficiency is growing during the first 500 hours life until it stabilizes to the values mentioned in the catalogue.

3.4 Selbsthemmung

Aussenbremsen sind bei Anwendungen zu benutzen, bei denen Rückbewegung vermeiden werden muss oder die Last auch im Falle von Fehlen an Speisung gehalten werden muss.

Einige Schneckengetriebe sind selbsthemmend. Je höher die Unterersetzung ist, desto höher ist die Selbsthemmung, da diese stark vom jeweiligen Wirkungsgrad abhängig ist. Um eine höhere Selbsthemmung zu erreichen, wählen Sie bitte höhere Untersetzungsverhältnisse.

Bitte beachten Sie, dass der Wirkungsgrad der Getriebe in den ersten 500 Betriebsstunden ansteigt und sich erst anschließend auf die im Katalog angegebenen Werte stabilisiert.

Irreversibilità statica

Condizione di impedimento alla rotazione comandata dall'albero lento senza escludere possibili ritorni lenti nel caso in cui il carico sia sottoposto a vibrazioni.

Rs < 0.45 si ha irreversibilità
Rs = 0.45 ÷ 0.55 irreversibilità incerta
Rs > 0.55 si ha reversibilità

Static irreversibility

Static irreversibility occurs when the rotation controlled by the output shaft is hindered; possible slow returns cannot be excluded should the load be subject to vibrations.

Rs < 0.45 provides irreversibility
Rs = 0.45 ÷ 0.55 irreversibility is uncertain
Rs > 0.55 reversibility is possible

Statische Selbsthemmung

Statische Selbsthemmung liegt vor, wenn die von Abtriebswelle gesteuerten Drehung gehindert wird. Langsamer Rücklauf ist möglich, falls die Last Schwingungen ausgesetzt wird.

Rs < 0.45 es liegt Selbsthemmung vor
Rs = 0.45 ÷ 0.55 ungewisse Selbsthemmung
Rs > 0.55 es liegt Reversibilität vor

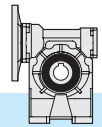

Irreversibilità dinamica

Condizione di arresto e quindi di sostegno del carico nel momento in cui cessa l'azione di comando. La condizione è più difficile da ottenere in quanto viene influenzata dal rendimento dinamico, dalla velocità di rotazione, da eventuali vibrazioni che il carico può generare e dalla direzione del movimento rispetto al carico.

Quest'ultima condizione è molto evidente nei sollevamenti: un carico in salita, cessando l'azione di comando, deve arrestarsi e quindi assumere velocità zero (rendimento statico) prima di invertire il moto e cadere per gravità.

Un carico in discesa tende invece a proseguire nel suo moto ostacolato, nella caduta, dal solo rendimento dinamico.

Rd < 0.45 si ha irreversibilità
Rd = 0.45 ÷ 0.55 irreversibilità incerta
Rd > 0.55 si ha reversibilità

Dynamic irreversibility

Dynamic irreversibility is characterized by stillstand and hold of the load when the drive stops. It is more difficult to achieve this condition because it is influenced by dynamic efficiency, speed of rotation and possible vibrations generated by the motion direction with regard to the load.

This last condition is much more evident during the lifting : if the drive stops during the lifting of the load this has to come to a speed equals to zero (static irreversibility) before the reversal of motion rotation and its drop for gravity.

On the contrary the load during its descent gets its motion obstructed by its dynamic efficiency.

Rd < 0.45 provides irreversibility
Rd = 0.45 ÷ 0.55 irreversibility is uncertain
Rd > 0.55 reversibility is possible

Dynamische Selbsthemmung

Stillstand und Stütze der Last beim Aussetzen der Steuerung. Diese Bedingung ist schwieriger zu erreichen, da sie vom dynamischen Wirkungsgrad, der Drehzahl und von der Last verursachten möglichen Vibrationen abhängig ist

Dieser letzte Fall kommt bei Hubanwendungen stark zu tragen. Wenn der Antrieb während dem Hub stoppt, muss die Last eine Geschwindigkeit von annähernd null erreichen (statische Irreversibilität), bevor die Rotation sich umkehrt und die Last durch die Gravitation nach unten fährt.

Dem entgegengesetzt bekommt die Last durch die Abwärtsbewegung Ihre dynamische Effizienz.

Rd < 0.45 es liegt Selbsthemmung vor
Rd = 0.45 ÷ 0.55 ungewisse Selbsthemmung
Rd > 0.55 es liegt Reversibilität vor

3.5 Gioco angolare

Gioco angolare standard

Misurato bloccando l'albero entrata, e ruotando l'albero uscita nelle due direzioni applicando la coppia strettamente necessaria a creare il contatto tra i denti degli ingranaggi, al massimo pari al 2% della coppia nominale (T_{2M}).

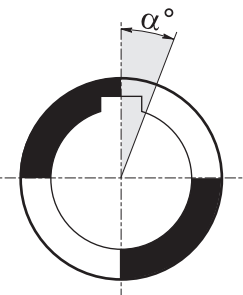

3.5 Backlash

Backlash

Angular backlash measured after having blocked the input shaft by rotating output shaft in both directions and applying the torque which is strictly necessary to create a contact between the teeth of the gears. The applied torque should be at most 2% of the max. torque (T_{2M}).

3.5 Winkelspiel

Winkelspiel

Nachdem die Antriebswelle blockiert worden ist, darf das Winkelspiel auf die Abtriebswelle bemessen werden. Dabei soll die Antriebswelle in beiden Richtungen gedreht werden und ein Drehmoment ausgeübt werden, das zur Entstehen eines Kontaktes zwischen den Zähnen genuegt. Das ausgeübte Drehmoment soll höchstens 2% des max. von Getrieben garantierten Drehmoment (T_{2M}) sein.

GK						
i_n	30	40	50	63	75	89
	max	max	max	max	max	max
5	16'	13.5'	10.5'	10'	/	/
7.5	16'	13.5'	10.5'	10'	10'	9.5'
10	16'	13.5'	10.5'	10'	10'	9'
15	16'	13.5'	10.5'	10'	10'	9'
20	14.5'	12'	9.5'	8.5'	8.5'	8.5'
25	14.5'	12'	9.5'	8.5'	8.5'	8.5'
30	14.5'	12'	8.5'	8.5'	8.5'	8.5'
40	14.5'	12'	9.5'	8.5'	8.5'	8'
50	14'	12'	9.5'	8.5'	8.5'	8'
65	14'	12'	9'	8'	8'	8'
80	13.5'	11.5'	9'	7.5'	7.5'	7.5'
100	13'	11'	9'	7.5'	7.5'	7.5'

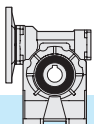

3.6 Carichi radiali

Carichi radiali Fr_2 e assiali Fa_2 sull'albero uscita [N]

Se il carico radiale sull'albero non è applicato a metà della sporgenza dell'albero, il valore del carico ammissibile deve essere valutato utilizzando la formula che si riferisce ad Fry_2 , in cui i valori di a, b e Fr_2 sono riportati nelle tabelle relative ai carichi radiali.

Nel caso di alberi bisporgenti il valore del carico applicabile a ciascuna estremità è uguale ai 2/3 del valore di tabella, purchè i carichi applicati siano uguali di intensità e direzione ed agiscano nello stesso senso. Diversamente contattare il servizio tecnico.

3.6 Radial load

Fr_2 radial loads and Fa_2 axial loads on the output shaft [N]

Should the radial load affect the shaft not at the half-way point of its projection but at a different point, the value of the admissible load has to be calculated using the Fry_2 formula: a, b and Fr_2 values are reported in the radial load tables.

With regard to double-projecting shafts, the load applicable at each end is 2/3 of the value given in the table, on condition that the applied loads feature same intensity and direction and that they act in the same direction.

Otherwise please contact the technical department.

3.6 Radialbelastungen

Fr_2 Radialbelastungen und Fa_2 Axialbelastungen auf die Abtriebswelle [N]

Falls die Radialbelastungen nicht in dem Mittelpunkt der herausragenden Welle sondern in einem anderen Punkt wirken, soll die zulässige Belastung mit der Formel bezüglich Fry_2 kalkuliert werden: a, b und Fr_2 Werte sind aus der Tabelle der Radialbelastungen zu entnehmen.

Bei doppelseitigen Abtriebswellen ist die Belastung, die an jedem Ende anwendbar ist, 2/3 des in der Tabelle angegebenen Wertes unter der Bedingung, dass die Belastungen die selbe Stärke und Richtung aufweisen und dass sie in der selben Richtung wirken. Andernfalls muß mit dem technischen Büro Rücksprache gehalten werden.

I carichi radiali indicati nelle tabelle si intendono applicati a metà della sporgenza dell'albero e sono riferiti ai riduttori operanti con fattore di servizio 1.

The radial loads indicated in the chart are considered to be applied at the half-way point of the shaft projection, and refer to gear units operating with service factor 1.

Die Radialbelastungen, die in den Tabellen angegeben werden, gelten für Ansatzpunkte in der Mitte des herausragenden Wellenteils und für Getriebe mit Betriebsfaktor 1.

		GK											
$n_1=1400$ rpm		30		40		50		63		75		89	
i_n	n_2 [rpm]	a = 66.5 b = 49		a = 83.5 b = 60.5		a = 102 b = 73.5		a = 122.5 b = 93.5		a = 134 b = 100		a = 163 b = 118	
		Fr_2	Fa_2	Fr_2	Fa_2	Fr_2	Fa_2	Fr_2	Fa_2	Fr_2	Fa_2	Fr_2	Fa_2
5	280	700	140	1400	280	1400	300	1800	360	/	/	/	/
7.5	187	750	150	1500	300	1650	330	2100	420	2500	500	2600	520
10	140	800	160	1600	320	1800	360	2300	460	2800	560	3000	600
15	93	850	170	1700	340	1950	390	2600	520	3000	600	3400	680
20	70	900	180	1800	360	2200	440	2800	560	3300	660	3800	760
25	56	950	190	1900	380	2400	480	3100	620	3700	740	4100	820
30	47	1000	200	2000	400	2600	520	3400	680	4000	800	4500	900
40	35	1050	210	2100	420	2850	570	3700	740	4400	880	4900	980
50	28	1100	220	2200	440	3100	620	4000	800	4850	970	5300	1060
60	23	1150	230	2400	480	3200	640	4200	840	5000	1000	5600	1120
63	22	1250	250	2500	500	3400	680	4450	890	5300	1060	5900	1180
80	17.5	1350	270	2700	540	3800	760	4900	980	5800	1160	6500	1300
100	14	1500	300	3000	600	4000	800	5400	1080	6500	1300	7000	1400

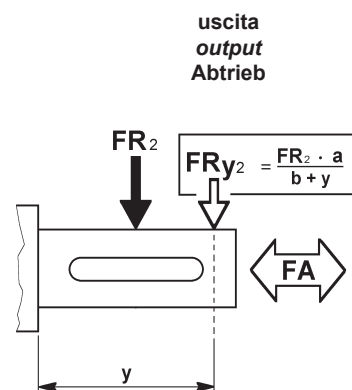

3.7 Senso di rotazione

3.7 Direction of rotation

3.7 Drehrichtung

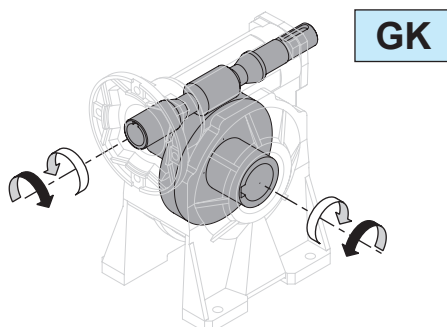

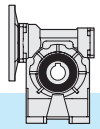

3.8 Lubrificazione

I riduttori a vite senza fine serie GK sono forniti completi di lubrificante sintetico per uso alimentare: OLIO FUCHS CASSIDA FLUID 320.

Si raccomanda di precisare sempre, in fase di ordine, la posizione di montaggio desiderata.

Per ulteriori dettagli consultare pag. 17 paragrafo 1.6

Posizioni di montaggio

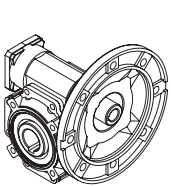

B3

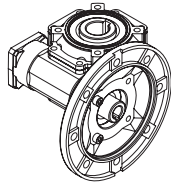

B6

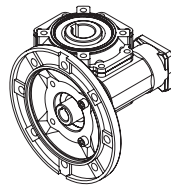

B7

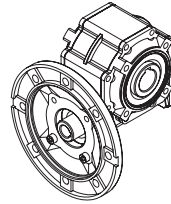

B8

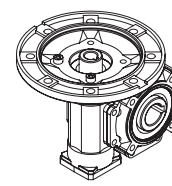

V5

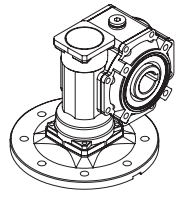

V6

E' presente un solo tappo di riempimento olio.

3.8 Lubrication

The GK series worm gearboxes are supplied complete with synthetic lubricant for food use: FUCHS CASSIDA FLUID 320 OIL.

It is recommended to always specify the desired assembly position when placing the order.

For further details, please see page 17 paragraph 1.6

Mounting positions

Aluminum housings have one filling plug only.

3.8 Schmierung

Die Schneckengetriebe der Serie GK werden mit synthetischem Lebensmittelöl FUCHS CASSIDA FLUID 320 geliefert.

Es wird empfohlen, bei der Bestellung immer die gewünschte Einbaulage anzugeben.

Für weitere Details siehe Seite 17, Absatz 1.6.

Einbaulagen

Gehäuse aus Aluminium verfügen über nur eine Einfüllschraube.

		Q.tà olio / Oil quantity / Schmiermittelmenge [lt]			
		Posizione di montaggio / Mounting position / Einbaulage			
		B3	B6 - B7	B8	V5 - V6
GK	30	0.015	0.030		0.015
	40	0.040	0.060		0.040
	50	0.080	0.120		0.080
	63	0.160	0.220		0.160
	75	0.260	0.340		0.260
	89	1	0.8	0.8	1.3

3.9 Posizione morsettiera

3.9 Terminal board position

3.9 Lage der Klemmenkaste

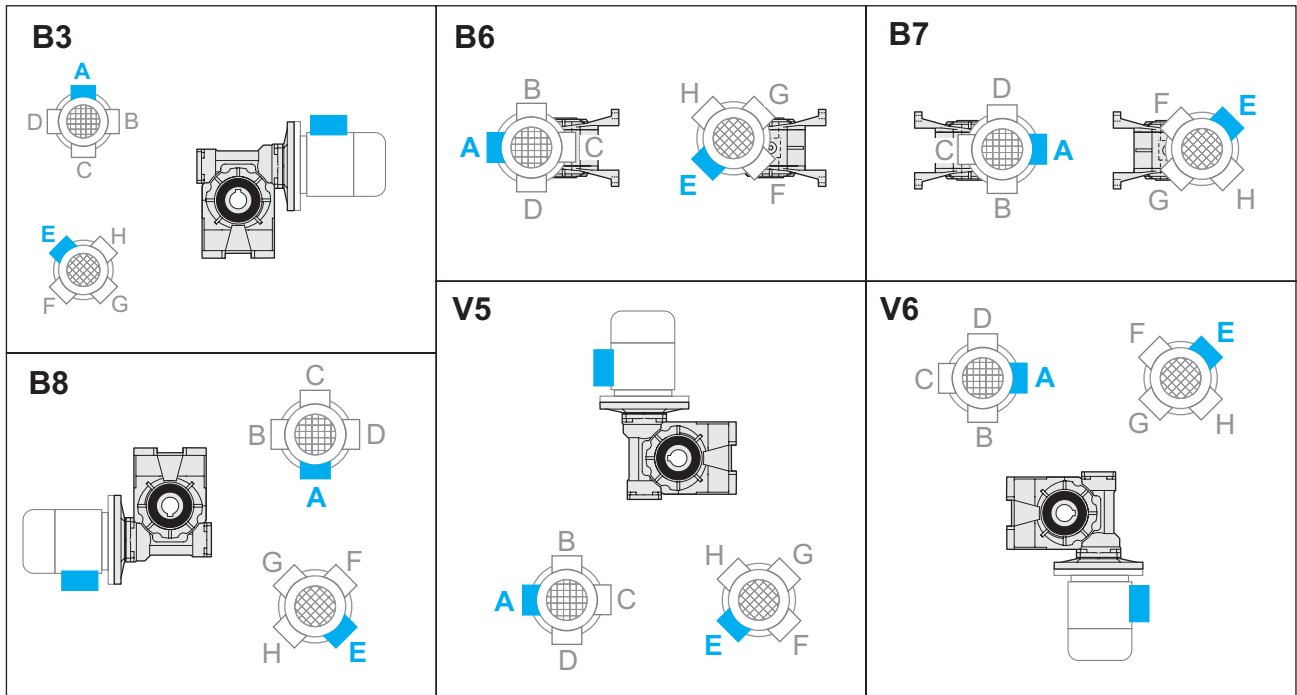

Specificare sempre in fase di ordinazione la posizione di montaggio e la forma costruttiva.

Posizione morsettiera v. pag. 55 (PM=1; PM=2)

Mounting position always to be specified when ordering.

Terminal board position see page 55 (PM=1; PM=2)

Bei der Bestellung immer die gewünschte Montageposition und Bauform angeben.

Lage der Klemmenkaste Seite 55 (PM=1; PM=2)

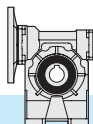

3.10 Dati tecnici

3.10 Technical data

3.10 Technische Daten

GKC 30	$n_1 = 2800$				MOTORI / MOTORS / ENGINE GHA CLASSIC				Input - IEC	
	i_n	n_2 [min ⁻¹]	Rd	P_{10}	T_2 [Nm]	P_1 [kW]	FS'	B5/B14		
								63	56	
Kg 1.2	5	560	0.89	—	5.6	0.37	2.5	63	56	
	7.5	373	0.86		8	0.37	2.0			
	10	280	0.84		11	0.37	1.5			
	15	187	0.81		15	0.37	1.1			
	20	140	0.76		13	0.25	1.2			
	25	112	0.74		16	0.25	1.0			
	30	93	0.71		13	0.18	1.0			
	40	70	0.65		16	0.18	1.0			
	50	56	0.62		14	0.13	1.1			
	65	43	0.57		17	0.13	1.0			
	80	35	0.54		13	0.09	1.0			
	100	28	0.52		16	0.09	0.8			

GKC 30	$n_1 = 1400$				MOTORI / MOTORS / ENGINE GHA CLASSIC				Input - IEC	
	i_n	n_2 [min ⁻¹]	Rd	P_{10}	T_2 [Nm]	P_1 [kW]	FS'	B5/B14		
								63	56	
Kg 1.2	5	280	0.87	0.40	6.5	0.22	2.9	63	56	
	7.5	187	0.84	0.40	9	0.22	2.2			
	10	140	0.82	0.40	12	0.22	1.8			
	15	93	0.77	0.30	17	0.22	1.3			
	20	70	0.72	0.20	18	0.18	1.1			
	25	56	0.69	0.20	21	0.18	1.0			
	30	47	0.66	0.20	18	0.13	1.1			
	40	35	0.59	0.20	21	0.13	1.0			
	50	28	0.55	0.20	17	0.09	1.1			
	65	22	0.51	0.10	20	0.09	1.0			
	80	18	0.48	0.10	16	0.06	1.0			
	100	14	0.45	0.10	18	0.06	0.8			

GKC 30	$n_1 = 900$				MOTORI / MOTORS / ENGINE GHA CLASSIC				Input - IEC	
	i_n	n_2 [min ⁻¹]	Rd	P_{10}	T_2 [Nm]	P_1 [kW]	FS'	B5/B14		
								63	56	
Kg 1.2	5	180	0.85	—	5.9	0.13	3.9	63	56	
	7.5	120	0.82		9	0.13	2.9			
	10	90	0.80		11	0.13	2.3			
	15	60	0.75		15	0.13	1.6			
	20	45	0.69		19	0.13	1.2			
	25	36	0.66		23	0.13	1.1			
	30	30	0.63		18	0.09	1.2			
	40	23	0.55		21	0.09	1.1			
	50	18	0.52		16	0.06	1.3			
	65	14	0.48		20	0.06	1.1			
	80	11	0.44		11	0.03	1.7			
	100	9	0.42		13	0.03	1.1			

GKC 30	$n_1 = 500$				MOTORI / MOTORS / ENGINE GHA CLASSIC				Input - IEC	
	i_n	n_2 [min ⁻¹]	Rd	P_{10}	T_2 [Nm]	P_1 [kW]	FS'	B5/B14		
								63	56	
Kg 1.2	5	100	0.83	—	—	—	—	63	56	
	7.5	67	0.80		—	—	—			
	10	50	0.77		—	—	—			
	15	33	0.72		—	—	—			
	20	25	0.66		—	—	—			
	25	20	0.62		—	—	—			
	30	17	0.59		—	—	—			
	40	13	0.51		—	—	—			
	50	10	0.48		—	—	—			
	65	8	0.43		—	—	—			
	80	6	0.40		—	—	—			
	100	5	0.38		—	—	—			

* **ATTENZIONE:** la coppia massima utilizzabile $[T_{2M}]$ deve essere calcolata utilizzando il fattore di servizio: $T_{2M} = T_2 \times FS'$

* **WARNING:** Maximum allowable torque $[T_{2M}]$ must be calculated using the following service factor: $T_{2M} = T_2 \times FS'$

* **ACHTUNG:** das max. anwendbare Drehmoment $[T_{2M}]$ muss mit folgendem Betriebsfaktor berechnet werden: $T_{2M} = T_2 \times FS'$

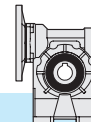

3.10 Dati tecnici

3.10 Technical data

3.10 Technische Daten

GKC 40	$n_1 = 2800$				MOTORI / MOTORS / ENGINE GHA CLASSIC					
	i_n	n_2 [min ⁻¹]	Rd	P_{t0}	T_2 [Nm]	P_1 [kW]	FS'	Input - IEC B5/B14		
								71	63	—
Kg 2.0	5	560	0.88	—	11.3	0.75	2.2	71	63	—
	7.5	373	0.87		17	0.75	1.8			
	10	280	0.86		22	0.75	1.4			
	15	187	0.82		32	0.75	1.0			
	20	140	0.80		30	0.55	1.0			
	25	112	0.76		24	0.37	1.1			
	30	93	0.73		28	0.37	1.3			
	40	70	0.70		24	0.25	1.4			
	50	56	0.65		28	0.25	1.1			
	65	43	0.61		24	0.18	1.2			
80	35	0.58	21	0.13	1.3					
100	28	0.55	24	0.13	1.0					

GKC 40	$n_1 = 1400$				MOTORI / MOTORS / ENGINE GHA CLASSIC					
	i_n	n_2 [min ⁻¹]	Rd	P_{t0}	T_2 [Nm]	P_1 [kW]	FS'	Input - IEC B5/B14		
								71	63	—
Kg 2.0	5	280	0.87	0.80	16.3	0.55	2.1	71	63	—
	7.5	187	0.85	0.80	24	0.55	1.7			
	10	140	0.83	0.70	31	0.55	1.3			
	15	93	0.79	0.50	30	0.37	1.4			
	20	70	0.76	0.50	38	0.37	1.0			
	25	56	0.72	0.40	31	0.25	1.1			
	30	47	0.68	0.40	35	0.25	1.2			
	40	35	0.64	0.30	38	0.22	1.0			
	50	28	0.59	0.30	36	0.18	1.1			
	65	22	0.54	0.20	31	0.13	1.1			
80	18	0.52	0.20	31	0.11	1.1				
100	14	0.49	0.20	30	0.09	0.9				

GKC 40	$n_1 = 900$				MOTORI / MOTORS / ENGINE GHA CLASSIC					
	i_n	n_2 [min ⁻¹]	Rd	P_{t0}	T_2 [Nm]	P_1 [kW]	FS'	Input - IEC B5/B14		
								71	63	—
Kg 2.0	5	180	0.85	—	16.7	0.37	2.5	71	63	—
	7.5	120	0.83		25	0.37	2.0			
	10	90	0.81		32	0.37	1.5			
	15	60	0.76		45	0.37	1.1			
	20	45	0.74		39	0.25	1.2			
	25	36	0.69		33	0.18	1.3			
	30	30	0.65		37	0.18	1.3			
	40	23	0.61		33	0.13	1.3			
	50	18	0.55		38	0.13	1.1			
	65	14	0.51		32	0.09	1.2			
80	11	0.48	37	0.09	1.0					
100	9	0.45	29	0.06	1.0					

GKC 40	$n_1 = 500$				MOTORI / MOTORS / ENGINE GHA CLASSIC					
	i_n	n_2 [min ⁻¹]	Rd	P_{t0}	T_2 [Nm]	P_1 [kW]	FS'	Input - IEC B5/B14		
								71	63	—
Kg 2.0	5	100	0.83	—	7.1	0.09	7.1	71	63	—
	7.5	67	0.81		10	0.09	5.5			
	10	50	0.79		14	0.09	4.4			
	15	33	0.73		19	0.09	3.1			
	20	25	0.70		24	0.09	2.3			
	25	20	0.65		28	0.09	1.7			
	30	17	0.61		31	0.09	1.8			
	40	13	0.57		39	0.09	1.3			
	50	10	0.51		44	0.09	1.2			
	65	8	0.46		52	0.09	0.9			
80	6	0.44	61*	0.09	0.7*					
100	5	0.41	71*	0.09	0.4*					

* **ATTENZIONE:** la coppia massima utilizzabile [T_{2M}] deve essere calcolata utilizzando il fattore di servizio: $T_{2M} = T_2 \times FS'$

* **WARNING:** Maximum allowable torque [T_{2M}] must be calculated using the following service factor: $T_{2M} = T_2 \times FS'$

* **ACHTUNG:** das max. anwendbare Drehmoment [T_{2M}] muss mit folgendem Betriebsfaktor berechnet werden: $T_{2M} = T_2 \times FS'$

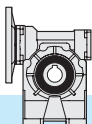

3.10 Dati tecnici

3.10 Technical data

3.10 Technische Daten

GKC 50	$n_1 = 2800$				MOTORI / MOTORS / ENGINE GHA CLASSIC					
	i_n	n_2 [min ⁻¹]	Rd	P_{t0}	T_2 [Nm]	P_1 [kW]	FS'	Input - IEC B5/B14		
								80	71	63
Kg 3.4	5	560	0.89	—	22.8	1.5	1.9	80	71	—
	7.5	373	0.88		34	1.5	1.5			
	10	280	0.86		44	1.5	1.2			
	15	187	0.84		47	1.1	1.2			
	20	140	0.81		42	0.75	1.4			
	25	112	0.78		50	0.75	1.0			
	30	93	0.75		42	0.55	1.3			
	40	70	0.72		54	0.55	1.0			
	50	56	0.68		43	0.37	1.3			
	65	43	0.64		53	0.37	1.0			
	80	35	0.61		41	0.25	1.2			
100	28	0.58	35	0.18	1.3					

GKC 50	$n_1 = 1400$				MOTORI / MOTORS / ENGINE GHA CLASSIC					
	i_n	n_2 [min ⁻¹]	Rd	P_{t0}	T_2 [Nm]	P_1 [kW]	FS'	Input - IEC B5/B14		
								80	71	63
Kg 3.4	5	280	0.87	1.2	26.7	0.9	2.3	80	71	—
	7.5	187	0.86	1.2	40	0.9	1.8			
	10	140	0.84	1.0	52	0.9	1.4			
	15	93	0.80	0.80	74	0.9	1.0			
	20	70	0.78	0.70	58	0.55	1.3			
	25	56	0.74	0.60	47	0.37	1.4			
	30	47	0.71	0.60	53	0.37	1.2			
	40	35	0.67	0.50	68	0.37	1.0			
	50	28	0.62	0.40	53	0.25	1.3			
	65	22	0.58	0.40	64	0.25	1.0			
	80	18	0.54	0.40	53	0.18	1.1			
100	14	0.51	0.30	45	0.13	1.2				

GKC 50	$n_1 = 900$				MOTORI / MOTORS / ENGINE GHA CLASSIC					
	i_n	n_2 [min ⁻¹]	Rd	P_{t0}	T_2 [Nm]	P_1 [kW]	FS'	Input - IEC B5/B14		
								80	71	63
Kg 3.4	5	180	0.85	—	33.8	0.75	2.2	80	71	—
	7.5	120	0.84		50	0.75	1.6			
	10	90	0.82		66	0.75	1.3			
	15	60	0.78		68	0.55	1.3			
	20	45	0.75		59	0.37	1.5			
	25	36	0.71		70	0.37	1.1			
	30	30	0.67		79	0.37	1.0			
	40	23	0.63		67	0.25	1.1			
	50	18	0.59		78	0.25	1.0			
	65	14	0.54		67	0.18	1.1			
	80	11	0.51		56	0.13	1.2			
100	9	0.47	45	0.09	1.3					

GKC 50	$n_1 = 500$				MOTORI / MOTORS / ENGINE GHA CLASSIC					
	i_n	n_2 [min ⁻¹]	Rd	P_{t0}	T_2 [Nm]	P_1 [kW]	FS'	Input - IEC B5/B14		
								80	71	63
Kg 3.4	5	100	0.84	—	14.3	0.18	6.4	80	71	—
	7.5	67	0.82		21	0.18	4.7			
	10	50	0.80		28	0.18	3.8			
	15	33	0.75		39	0.18	2.7			
	20	25	0.72		50	0.18	2.1			
	25	20	0.68		58	0.18	1.5			
	30	17	0.63		65	0.18	1.5			
	40	13	0.59		81	0.18	1.2			
	50	10	0.54		93	0.18	1.0			
	65	8	0.50		56	0.09	1.5			
	80	6	0.46		63	0.09	1.2			
100	5	0.43	74	0.09	0.8					

* **ATTENZIONE:** la coppia massima utilizzabile $[T_{2M}]$ deve essere calcolata utilizzando il fattore di servizio: $T_{2M} = T_2 \times FS'$

* **WARNING:** Maximum allowable torque $[T_{2M}]$ must be calculated using the following service factor: $T_{2M} = T_2 \times FS'$

* **ACHTUNG:** das max. anwendbare Drehmoment $[T_{2M}]$ muss mit folgendem Betriebsfaktor berechnet werden: $T_{2M} = T_2 \times FS'$

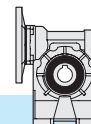



3.10 Dati tecnici

3.10 Technical data

3.10 Technische Daten

GKC 63	$n_1 = 2800$				MOTORI / MOTORS / ENGINE GHA CLASSIC				Input - IEC B5/B14		
	i_n	n_2 [min ⁻¹]	Rd	P_{t0}	T_2 [Nm]	P_1 [kW]	FS'	90	80	71	
 5.7	5	560	0.89	—	45.5	3	1.7				—
	7.5	373	0.88		68	3	1.3				
	10	280	0.87		89	3	1.1				
	15	187	0.84		95	2.2	1.0				
	20	140	0.83		85	1.5	1.3				
	25	112	0.81		76	1.1	1.2				
	30	93	0.77		87	1.1	1.3				
	40	70	0.74		111	1.1	1.1				
	50	56	0.70		90	0.75	1.1				
	65	43	0.67		81	0.55	1.2				
	80	35	0.64		65	0.37	1.4				
100	28	0.60	75	0.37	1.1						

GKC 63	$n_1 = 1400$				MOTORI / MOTORS / ENGINE GHA CLASSIC				Input - IEC B5/B14		
	i_n	n_2 [min ⁻¹]	Rd	P_{t0}	T_2 [Nm]	P_1 [kW]	FS'	90	80	71	
 5.7	5	280	0.88	1.8	54	1.8	2.0				—
	7.5	187	0.87	1.8	80	1.8	1.5				
	10	140	0.85	1.6	105	1.8	1.2				
	15	93	0.81	1.2	125	1.5	1.1				
	20	70	0.80	1.2	120	1.1	1.2				
	25	56	0.77	1.0	118	0.9	1.0				
	30	47	0.73	0.90	134	0.9	1.1				
	40	35	0.69	0.80	142	0.75	1.1				
	50	28	0.65	0.70	122	0.55	1.0				
	65	22	0.61	0.60	100	0.37	1.2				
	80	18	0.58	0.60	79	0.25	1.4				
100	14	0.53	0.50	91	0.25	1.1					

GKC 63	$n_1 = 900$				MOTORI / MOTORS / ENGINE GHA CLASSIC				Input - IEC B5/B14		
	i_n	n_2 [min ⁻¹]	Rd	P_{t0}	T_2 [Nm]	P_1 [kW]	FS'	90	80	71	
 5.7	5	180	0.87	—	69	1.5	1.9				—
	7.5	120	0.85		102	1.5	1.4				
	10	90	0.83		133	1.5	1.1				
	15	60	0.79		139	1.1	1.1				
	20	45	0.77		123	0.75	1.4				
	25	36	0.74		109	0.55	1.3				
	30	30	0.70		122	0.55	1.3				
	40	23	0.66		154	0.55	1.1				
	50	18	0.61		120	0.37	1.2				
	65	14	0.57		98	0.25	1.4				
	80	11	0.54		115	0.25	1.1				
100	9	0.50	95	0.18	1.2						

GKC 63	$n_1 = 500$				MOTORI / MOTORS / ENGINE GHA CLASSIC				Input - IEC B5/B14		
	i_n	n_2 [min ⁻¹]	Rd	P_{t0}	T_2 [Nm]	P_1 [kW]	FS'	90	80	71	
 5.7	5	100	0.85	—	20	0.25	8.3				—
	7.5	67	0.83		30	0.25	5.9				
	10	50	0.81		39	0.25	4.7				
	15	33	0.76		55	0.25	3.4				
	20	25	0.74		71	0.25	2.8				
	25	20	0.71		85	0.25	1.9				
	30	17	0.65		94	0.25	2.1				
	40	13	0.62		118	0.25	1.7				
	50	10	0.56		135	0.25	1.2				
	65	8	0.52		163	0.25	1.0				
	80	6	0.50		137	0.18	1.1				
100	5	0.45	77	0.09	1.6						

* **ATTENZIONE:** la coppia massima utilizzabile $[T_{2M}]$ deve essere calcolata utilizzando il fattore di servizio: $T_{2M} = T_2 \times FS'$

* **WARNING:** Maximum allowable torque $[T_{2M}]$ must be calculated using the following service factor: $T_{2M} = T_2 \times FS'$

* **ACHTUNG:** das max. anwendbare Drehmoment $[T_{2M}]$ muss mit folgendem Betriebsfaktor berechnet werden: $T_{2M} = T_2 \times FS'$

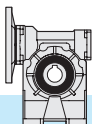

3.10 Dati tecnici

3.10 Technical data

3.10 Technische Daten

GKC 75 Kg 9.5	n₁ = 2800				MOTORI / MOTORS / ENGINE GHA CLASSIC							
	i _n	n ₂ [min ⁻¹]	Rd	P _{t0}	T ₂ [Nm]	P ₁ [kW]	FS'	Input - IEC B5/B14				
								112	100	90	80	
	7.5	373	0.89	—	125	5.5	1.0	112	100	90	80	71
	10	280	0.88		120	4	1.2					
	15	187	0.85		131	3	1.2					
	20	140	0.84		171	3	1.0					
	25	112	0.82		154	2.2	1.0					
	30	93	0.78		120	1.5	1.4					
	40	70	0.75		154	1.5	1.2					
	50	56	0.73		136	1.1	1.2					
	65	43	0.69		114	0.75	1.4					
	80	35	0.66		135	0.75	1.1					
	100	28	0.62		159	0.75	0.8					

GKC 75 Kg 9.5	n₁ = 1400				MOTORI / MOTORS / ENGINE GHA CLASSIC							
	i _n	n ₂ [min ⁻¹]	Rd	P _{t0}	T ₂ [Nm]	P ₁ [kW]	FS'	Input - IEC B5/B14				
								112	100	90	80	
	7.5	187	0.87	2.5	178	4	1.0	112	100	90	80	71
	10	140	0.86	2.3	176	3	1.1					
	15	93	0.83	1.9	187	2.2	1.1					
	20	70	0.81	1.7	199	1.8	1.1					
	25	56	0.78	1.5	200	1.5	1.0					
	30	47	0.74	1.2	167	1.1	1.3					
	40	35	0.71	1.1	213	1.1	1.1					
	50	28	0.67	1.0	206	0.9	1.0					
	65	22	0.63	0.90	154	0.55	1.3					
	80	18	0.60	0.80	180	0.55	1.0					
	100	14	0.56	0.70	210	0.55	0.8					

GKC 75 Kg 9.5	n₁ = 900				MOTORI / MOTORS / ENGINE GHA CLASSIC							
	i _n	n ₂ [min ⁻¹]	Rd	P _{t0}	T ₂ [Nm]	P ₁ [kW]	FS'	Input - IEC B5/B14				
								112	100	90	80	
	7.5	120	0.86	—	205	3	1.0	112	100	90	80	71
	10	90	0.84		197	2.2	1.2					
	15	60	0.81		231	1.8	1.0					
	20	45	0.78		250	1.5	1.1					
	25	36	0.76		221	1.1	1.1					
	30	30	0.71		249	1.1	1.0					
	40	23	0.67		214	0.75	1.3					
	50	18	0.64		186	0.55	1.3					
	65	14	0.59		151	0.37	1.5					
	80	11	0.56		177	0.37	1.2					
	100	9	0.52		203	0.37	0.9					

GKC 75 Kg 9.5	n₁ = 500				MOTORI / MOTORS / ENGINE GHA CLASSIC							
	i _n	n ₂ [min ⁻¹]	Rd	P _{t0}	T ₂ [Nm]	P ₁ [kW]	FS'	Input - IEC B5/B14				
								112	100	90	80	
	7.5	67	0.84	—	90	0.75	2.9	112	100	90	80	71
	10	50	0.82		118	0.75	2.4					
	15	33	0.78		167	0.75	1.7					
	20	25	0.75		216	0.75	1.5					
	25	20	0.72		260	0.75	1.1					
	30	17	0.67		288	0.75	1.1					
	40	13	0.63		265	0.55	1.2					
	50	10	0.59		210	0.37	1.3					
	65	8	0.55		251	0.37	1.0					
	80	6	0.52		197	0.25	1.2					
	100	5	0.47		161	0.18	1.3					

* **ATTENZIONE:** la coppia massima utilizzabile [T_{2M}] deve essere calcolata utilizzando il fattore di servizio: T_{2M} = T₂ x FS'

* **WARNING:** Maximum allowable torque [T_{2M}] must be calculated using the following service factor : T_{2M} = T₂ x FS'

* **ACHTUNG:** das max. anwendbare Drehmoment [T_{2M}] muss mit folgendem Betriebsfaktor berechnet werden: T_{2M} = T₂ x FS'

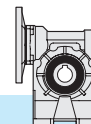

3.10 Dati tecnici

3.10 Technical data

3.10 Technische Daten

GKC 89	$n_1 = 2800$				MOTORI / MOTORS / ENGINE GHA CLASSIC					
	i_n	n_2 [min ⁻¹]	Rd	P_{t0}	T_2 [Nm]	P_1 [kW]	FS'	Input - IEC B5/B14		
								112 100	90	—
Kg 16.4	7.5	373	0.89	—	171	7.5	1.2			
	10	280	0.88		165	5.5	1.3			
	15	187	0.86		241	5.5	1.0			
	20	140	0.84		230	4	1.2			
	25	112	0.83		212	3	1.2			
	30	93	0.79		243	3	1.1			
	40	70	0.77		230	2.2	1.3			
	50	56	0.74		278	2.2	1.0			
	65	43	0.71		235	1.5	1.1			
	80	35	0.68		205	1.1	1.2			
	100	28	0.64		163	0.75	1.3			

GKC 89	$n_1 = 1400$				MOTORI / MOTORS / ENGINE GHA CLASSIC					
	i_n	n_2 [min ⁻¹]	Rd	P_{t0}	T_2 [Nm]	P_1 [kW]	FS'	Input - IEC B5/B14		
								112 100	90	—
Kg 11.5	7.5	187	0.88	3.0	247	5.5	1.2			
	10	140	0.86	2.5	236	4	1.3			
	15	93	0.84	2.2	256	3	1.2			
	20	70	0.82	2.0	334	3	1.1			
	25	56	0.80	1.8	299	2.2	1.1			
	30	47	0.76	1.5	340	2.2	1.0			
	40	35	0.72	1.3	355	1.8	1.1			
	50	28	0.69	1.1	353	1.5	1.0			
	65	22	0.65	1.0	317	1.1	1.0			
	80	18	0.63	1.0	309	0.9	1.0			
	100	14	0.58	0.80	217	0.55	1.2			

GKC 89	$n_1 = 900$				MOTORI / MOTORS / ENGINE GHA CLASSIC					
	i_n	n_2 [min ⁻¹]	Rd	P_{t0}	T_2 [Nm]	P_1 [kW]	FS'	Input - IEC B5/B14		
								112 100	90	—
Kg 11.5	7.5	120	0.86	—	206	3	1.7			
	10	90	0.85		270	3	1.3			
	15	60	0.82		286	2.2	1.3			
	20	45	0.79		371	2.2	1.1			
	25	36	0.77		369	1.8	1.0			
	30	30	0.73		416	1.8	1.0			
	40	23	0.69		440	1.5	1.0			
	50	18	0.66		384	1.1	1.0			
	65	14	0.62		319	0.75	1.1			
	80	11	0.59		274	0.55	1.2			
	100	9	0.54		313	0.55	1.0			

GKC 89	$n_1 = 500$				MOTORI / MOTORS / ENGINE GHA CLASSIC					
	i_n	n_2 [min ⁻¹]	Rd	P_{t0}	T_2 [Nm]	P_1 [kW]	FS'	Input - IEC B5/B14		
								112 100	90	—
Kg 11.5	7.5	67	0.84	—	91	0.75	4.7			
	10	50	0.83		118	0.75	3.7			
	15	33	0.79		169	0.75	2.7			
	20	25	0.76		219	0.75	2.3			
	25	20	0.74		265	0.75	1.7			
	30	17	0.68		294	0.75	1.6			
	40	13	0.65		371	0.75	1.4			
	50	10	0.61		439	0.75	1.1			
	65	8	0.57		388	0.55	1.1			
	80	6	0.54		305	0.37	1.3			
	100	5	0.49		344	0.37	1.0			

* **ATTENZIONE:** la coppia massima utilizzabile $[T_{2M}]$ deve essere calcolata utilizzando il fattore di servizio: $T_{2M} = T_2 \times FS'$

* **WARNING:** Maximum allowable torque $[T_{2M}]$ must be calculated using the following service factor: $T_{2M} = T_2 \times FS'$

* **ACHTUNG:** das max. anwendbare Drehmoment $[T_{2M}]$ muss mit folgendem Betriebsfaktor berechnet werden: $T_{2M} = T_2 \times FS'$

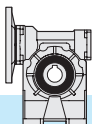

3.11 **Momenti d' inerzia** [Kg·cm²]
(riferiti all'albero veloce in entrata)

3.11 **Moments of inertia** [Kg·cm²]
(referred to input shaft)

3.11 **Trägheitsmoment** [Kg·cm²]
(bez. Antriebswelle)

	i_n	GKC	
		B5 - B14	
		IEC 56	IEC 63
GK30	5	0.130	0.127
	7.5	0.112	0.109
	10	0.103	0.100
	15	0.097	0.094
	20	0.095	0.092
	25	0.094	0.091
	30	0.093	0.090
	40	0.093	0.090
	50	0.092	0.089
	65	0.079	-
	80	0.079	-
	100	0.078	-

	i_n	GKC		
		B5 - B14		
		IEC 56	IEC 63	IEC 71
GK40	5	-	0.391	0.463
	7.5	-	0.321	0.356
	10	-	0.272	0.347
	15	-	0.266	0.340
	20	-	0.263	0.338
	25	-	0.262	0.337
	30	-	0.262	0.337
	40	-	0.261	0.336
	50	0.182	0.261	-
	65	0.182	0.261	-
	80	0.182	0.261	-
	100	0.182	0.261	-

	i_n	GKC		
		B5 - B14		
		IEC 63	IEC 71	IEC 80
GK50	5	-	0.922	1.046
	7.5	-	0.684	0.935
	10	-	0.602	0.853
	15	-	0.543	0.794
	20	-	0.523	0.774
	25	-	0.513	0.764
	30	-	0.508	0.759
	40	0.315	0.503	0.755
	50	0.313	0.501	-
	65	0.311	0.499	-
	80	0.310	0.498	-
	100	0.309	0.498	-

	i_n	GKC		
		B5 - B14		
		IEC 71	IEC 80	IEC 63
GK63	5	-	2.431	2.671
	7.5	-	1.949	2.269
	10	-	1.744	2.063
	15	-	1.597	1.916
	20	-	1.545	1.864
	25	-	1.514	1.833
	30	-	1.508	1.828
	40	0.966	1.495	-
	50	0.959	1.488	-
	65	0.955	1.484	-
	80	0.953	1.482	-
	100	0.952	1.481	-

	i_n	GKC			
		B5 - B14			
		IEC 71	IEC 80	IEC 90	IEC 100-112
GK75	7.5	-	-	3.712	4.462
	10	-	-	3.234	3.984
	15	-	-	2.893	3.643
	20	-	-	2.774	3.523
	25	-	-	2.709	3.458
	30	1.615	1.575	2.689	3.438
	40	-	1.573	2.659	-
	50	-	1.570	2.642	-
	65	1.609	1.569	2.633	-
	80	1.605	1.565	2.629	-
	100	1.602	1.562	2.626	-

	i_n	GKC		
		B5 - B14		
		IEC 80	IEC 90	IEC 100-112
GK89	7.5	-	6.898	7.671
	10	-	5.875	6.648
	15	-	5.144	5.917
	20	-	3.398	5.661
	25	-	3.256	5.520
	30	-	3.215	5.479
	40	-	3.151	-
	50	-	3.115	-
	65	2.024	3.096	-
	80	2.014	3.087	-
	100	2.008	3.080	-

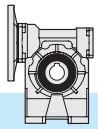

3.12 Dimensioni

3.12 Dimensions

3.12 Abmessungen

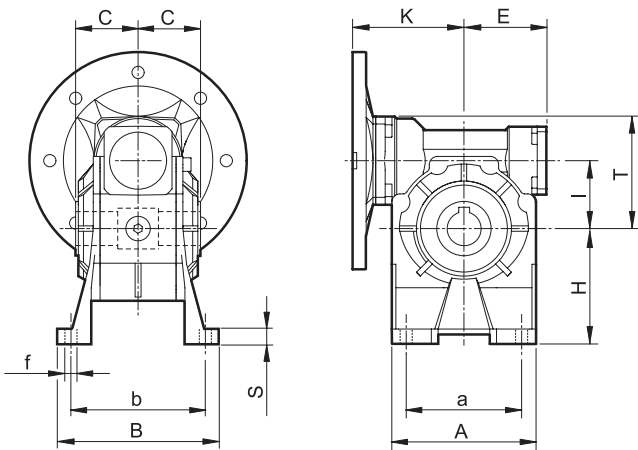

GKC..A

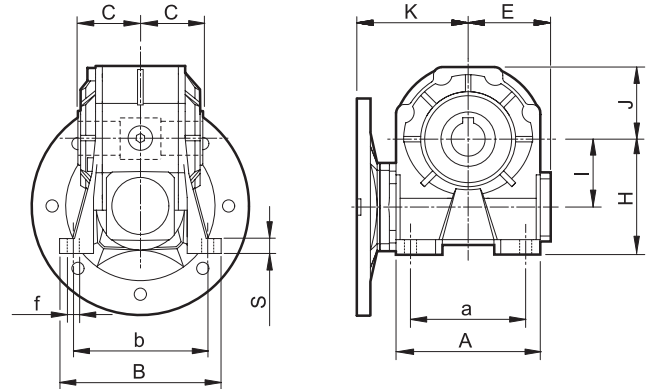

GKC..B

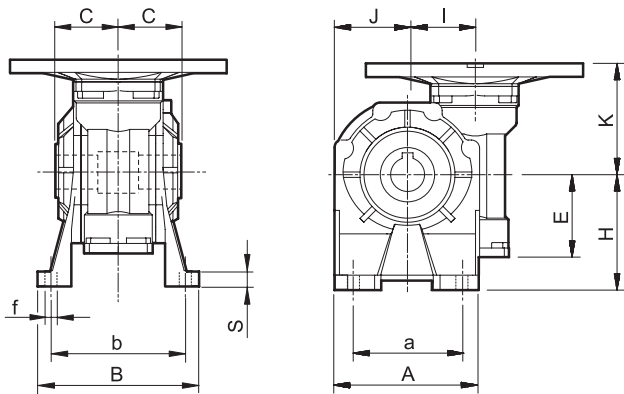

GKC..V

	30	40	50	63	75	89
b2	5	6	8	8	8	10
C	31.5	39	46	56	60	70
D2 H8	14	18	25	25	28	35
E	41	51	60	71	85	103
G h8	55	60	70	80	95	110
I	31.5	40	50	63	75	90
J	37.5	43.5	53.5	64	78	100
K	57	75	82	97	114 - 112 ⁽¹⁾	122
M	M6x8	M6x10	M8x10	M8x14	M8x14	M10x18
Pp	29	36.5	43.5	53	57	67
R	65	75	85	95	115	130
T	52.5	68.5	82.5	100.5	116.5	131.5
t2	16.3	20.8	28.3	28.3	31.3	38.3
X	1.5	1.5	1.5	2	2	2

(1): Solo per PAM 71B14 / Only for PAM 71B14 / Nur PAM 71B14

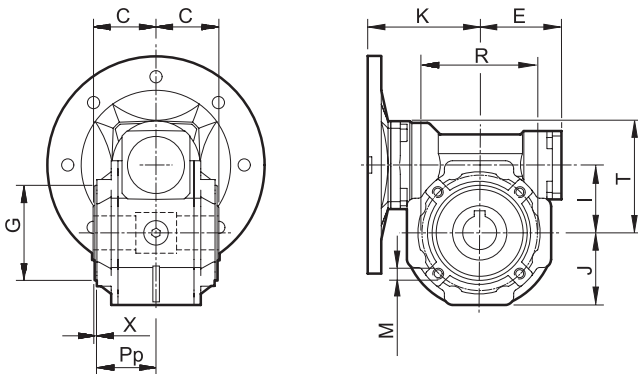

Flangia pendolare / Side cover for shaft mounting / Aufsteckflansch

	Piedi Feet Fuß	30	40	50	63	75	89
A	1	67	86.5	106	127.5	155.5	190
	2	67	86.5	106			190
a	1	40-52	70	63-85	95	120	140
	2	40-52	52	63-85			140
B	1	78	98	119	136	140	168
	2	78	98	119			168
b	1	66	84	99	111	115	140
	2	66	81	99			146
f	1	6.5	7	9	11	11	13
	2	6.5	8.5	9			11
H	1	52	71	85	100	115	135
	2	55	72	82			142
S	1	5	9	11	12	12	14
	2	8	10	8			14

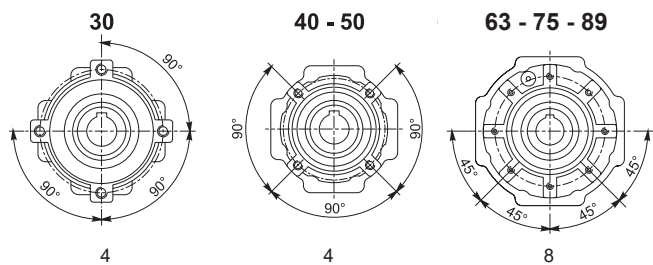

Fori / Holes / Bohrungen Fori / Holes / Bohrungen Fori / Holes / Bohrungen

GKC..P

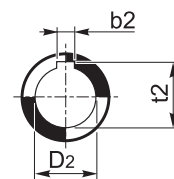

Albero uscita cavo
Hollow output shaft
Abtriebshohlwelle

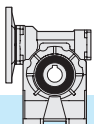

3.12 Dimensioni

3.12 Dimensions

3.12 Abmessungen

Flangia uscita / Output flange / Abtriebsflansch

Vista da A / View from A / Ansicht von A

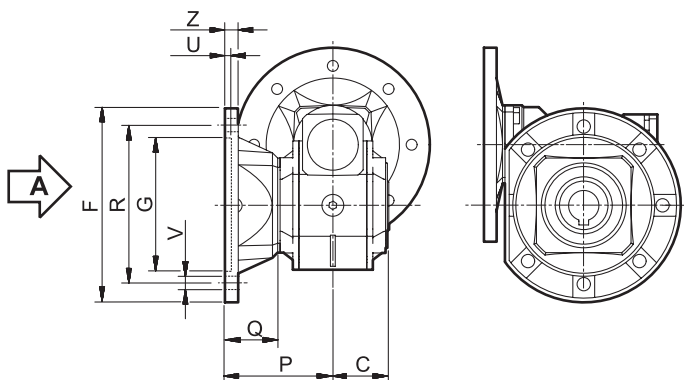

GKC..F

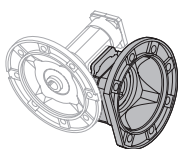

F...D
Standard

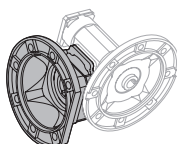

F...S

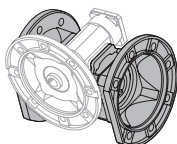

F...2

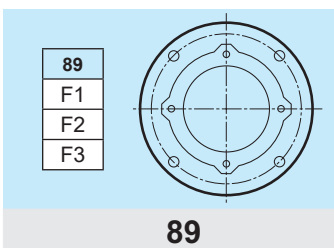
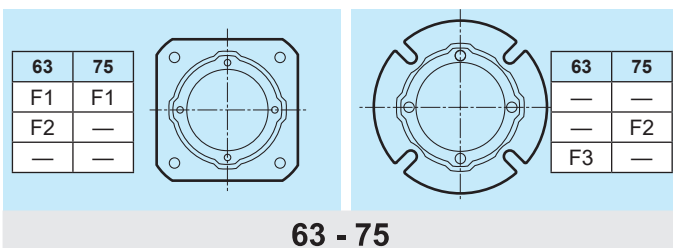
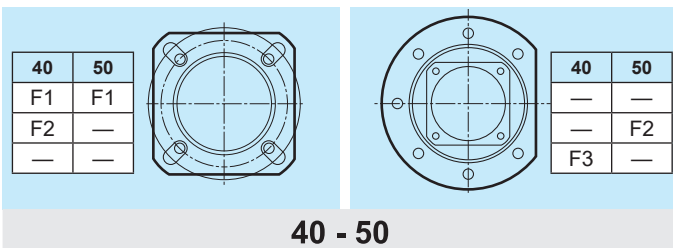
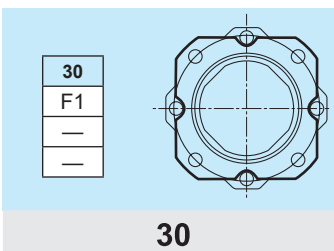

GKC	C	F		G H8	P	Q	R	U	V			Z
											Ø	
30	31.5		66	50	54.5	23	68	4	n° 4		6.5	6
40	39		85	60	67	28	75-90	4	n° 4		9	8
			85	60	97	58	75-90	4	n° 4		9	8
		140		95	80	41	115	5		n° 7	9	10
50	46		94	70	90	44	85-100	5	n° 4		11	10
		160		110	89	43	130	5		n° 7	11	11
63	56		142	115	82	26	150	5	n° 4		11	11
			142	115	112	56	150	5	n° 4		11	11
		160		110	80.5	24.5	130	5	n° 4		11	12
75	60		160	130	111	51	165	5	n° 4		13	12
		160		110	90	30	130	6	n° 4		11	13
89	70		200	152	111	41	175	5	n° 4		13	12
			200	152	151	81	175	5	n° 4		13	13
			200	130	110	40	165	6	n° 4		11	11

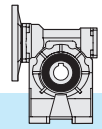

3.12 Dimensioni

3.12 Dimensions

3.12 Abmessungen

Flangia entrata / *Input flange* / Antriebsflansch

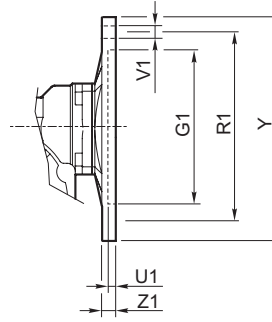
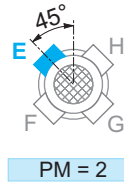
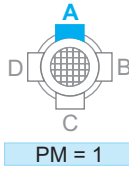

GKC	IEC	G ₁	PM		R ₁	U ₁	V ₁			Y	Z ₁	Diametro fori PAM / Holes diameter IEC / IEC Durchmesser																	
			1	2			Ø						5	7.5	10	15	20	25	30	40	50	65	80	100					
30	56 B5	80	•	•	100	4	7	8		120	8	9	9	9	9	9	9	9	9	9	9	9	9	9					
	56 B14	50	•	•	65	3.5	6	8		80	8	9	9	9	9	9	9	9	9	9	9	9	9	9					
	63 B5	95	•	•	115	4	9	8		140	8	11	11	11	11	11	11	11	11	11	11	/	/	/	/				
	63 B14	60	•	•	75	4	6	8		90	8	11	11	11	11	11	11	11	11	11	11	/	/	/	/				
40	56 B5	80	•	•	100	4	7	8		120	9	/	/	/	/	/	/	/	/	/	/	/	/	/	9	9	9	9	
	56 B14	50	•	•	65	3.5	6	8	4	80	8	/	/	/	/	/	/	/	/	/	/	/	/	/	9	9	9	9	
	63 B5	95	•	•	115	4	9	8		140	9	11	11	11	11	11	11	11	11	11	11	11	11	11	11	11	11	11	
	63 B14	60	•	•	75	3.5	6	8	4	90	8	11	11	11	11	11	11	11	11	11	11	11	11	11	11	11	11	11	
	71 B5	110	•	•	130	4.5	9	8		160	10	14	14	14	14	14	14	14	14	14	14	14	/	/	/	/	/	/	
	71 B14	70	•	•	85	3.5	7	8		105	8	14	14	14	14	14	14	14	14	14	14	14	/	/	/	/	/	/	
50	63 B5	95	•	•	115	4	9	8		140	9	/	/	/	/	/	/	/	/	/	/	/	11	11	11	11	11	11	
	63 B14	60	•	•	75	3.5	6	8	4	90	8	/	/	/	/	/	/	/	/	/	/	/	11	11	11	11	11	11	
	71 B5	110	•	•	130	4.5	9	8		160	10	14	14	14	14	14	14	14	14	14	14	14	14	14	14	14	14	14	
	71 B14	70	•	•	85	3.5	7	(n° 8)*	4	105	8	14	14	14	14	14	14	14	14	14	14	14	14	14	14	14	14	14	
	80 B5	130	•	•	165	4.5	11	8		200	10	19	19	19	19	19	19	19	19	19	19	19	/	/	/	/	/	/	
	80 B14	80	•	•	100	4	7	8		120	10	19	19	19	19	19	19	19	19	19	19	19	/	/	/	/	/	/	
63	71 B5	110	•	•	130	4.5	9	8		160	10	/	/	/	/	/	/	/	/	/	/	14	14	14	14	14	14	14	
	71 B14	70	•	•	85	3.5	7	8	4	105	10	/	/	/	/	/	/	/	/	/	/	14	14	14	14	14	14	14	
	80 B5	130	•	•	165	4.5	11	8		200	10	19	19	19	19	19	19	19	19	19	19	19	19	19	19	19	19	19	
	80 B14	80	•	•	100	4	7	8	4	120	10	19	19	19	19	19	19	19	19	19	19	19	19	19	19	19	19	19	
	90 B5	130	•	•	165	4.5	11	8		200	10	24	24	24	24	24	24	24	24	24	24	24	/	/	/	/	/	/	
	90 B14	95	•	•	115	4	8.5	8		140	10	24	24	24	24	24	24	24	24	24	24	24	/	/	/	/	/	/	
75	71 B5	110	•	•	130	4.5	9	8		160	10	/	/	/	/	/	/	/	/	/	14	14	/	/	14	14	14	14	
	71 B14	70	•	•	85	4	7	8	4	105	11	/	/	/	/	/	/	/	/	/	14	14	/	/	14	14	14	14	
	80 B5	130	•	•	165	4.5	11	8		200	10	/	/	/	/	/	/	/	/	/	19	19	19	19	19	19	19	19	
	80 B14	80	•	•	100	4	7	8	4	120	11	/	/	/	/	/	/	/	/	/	19	19	19	19	19	19	19	19	
	90 B5	130	•	•	165	4.5	11	8		200	10	/	24	24	24	24	24	24	24	24	24	24	24	24	24	24	24	24	
	90 B14	95	•	•	115	4	9	8	4	140	11	/	24	24	24	24	24	24	24	24	24	24	24	24	24	24	24	24	24
	100/112 B5	180	•	•	215	5	14	8		250	13	/	28	28	28	28	28	28	28	28	28	28	/	/	/	/	/	/	
	100/112 B14	110	•	•	130	4.5	9	8		160	11	/	28	28	28	28	28	28	28	28	28	28	/	/	/	/	/	/	
89	80 B5	130	•	•	165	4.5	11	8		200	10	/	/	/	/	/	/	/	/	/	/	/	/	/	19	19	19	19	
	80 B14	80	•	•	100	4	7	8	4	120	11	/	/	/	/	/	/	/	/	/	/	/	/	/	19	19	19	19	
	90 B5	130	•	•	165	4.5	11	8		200	10	/	24	24	24	24	24	24	24	24	24	24	24	24	24	24	24	24	
	90 B14	95	•	•	115	4	9	8	4	140	11	/	24	24	24	24	24	24	24	24	24	24	24	24	24	24	24	24	
	100/112 B5	180	•	•	215	5	14	8		250	13	/	28	28	28	28	28	28	28	28	28	28	/	/	/	/	/	/	
	100/112 B14	110	•	•	130	4.5	9	8		160	11	/	28	28	28	28	28	28	28	28	28	28	/	/	/	/	/	/	

* A richiesta, solo con corpo speciale / Upon request, only with special body / Auf Wunsch nur mit speziellen Körper

N.B.: Il montaggio STD di P_M=2 solo quando non è possibile il montaggio STD di P_M=1.

N.B.: E' possibile realizzare anche tutte le composizioni ibride ottenibili dalle flange esistenti.

N.B.: STD mounting of P_M=2 only if STD mounting of P_M=1 is not possible.

N.B.: it is possible to create hybrid combinations with the existing flanges.

ANMERKUNG: STD Montage von P_M=2 nur wenn STD Montage von P_M=1 unmöglich ist.

ANMERKUNG: Mischkombinationen mit der verfügbaren Flanschen sind möglich.

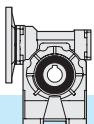

3.13 Entrata supplementare (vite bisporgente)

3.13 Additional input (double extended shaft)

3.13 Zusatzantrieb (beidseitige Welle)

S.e.A.

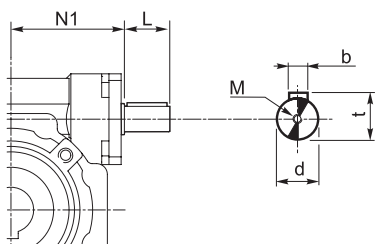

GKC	d j6	L	M	N1	b	t
30	9	15	M4x10	42.5	3	10.2
40	11	20	M4x12	52.5	4	12.5
50	14	25	M5x13	62.5	5	16
63	19	30	M8x20	72.5	6	21.5
75	24	40	M8x20	89	8	27
89	24	40	M8x20	108	8	27

3.14 Accessori (braccio di reazione)

3.14 Accessories (Torque arm)

3.14 Zubehör (Drehmomentstütze)

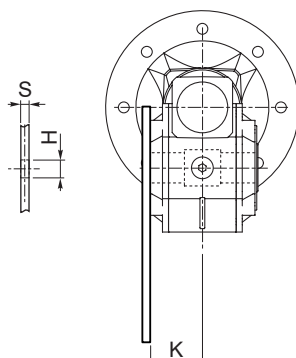
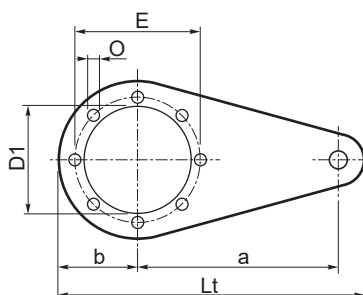

GK	a	b	D ₁	E	H	K	L _t	O	S
30	85	37	55	65	8	29	138	6.5 n°4	5
40	100	47	60	75	10	36.5	167	7 n°4	5
50	100	57.5	70	85	10	43.5	179	9 n°4	5
63	150	55	80	95	10	53	227	9 n°8	6
75	200	67	95	115	20	57	299	9 n°8	6
89	200	80	110	130	20	67	312	11 n°8	8

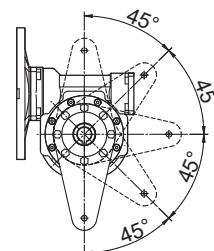
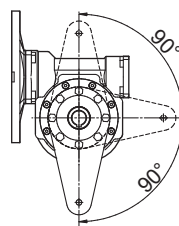

30 - 40 - 50

63 - 75 - 89

3.15 Lista parti di ricambio

3.15 Spare parts list

3.15 Ersatzteilliste

In fase di ordine delle parti di ricambio, specificare sempre n° particolare (vedi disegno esploso), data (1), n° codice (2) e n° variante (3).
(Vedi targhetta).

When ordering a spare part, the spare part number (see exploded technical drawing), the date (1), the code number (2) and the variant number (3) should always be reported.
(See plate)

Bei der Bestellung von Ersatzteilen sind Ersatzteilnummer (s. Explosionszeichnung), Datum (1), Artikelnummer (2) und Variantenummer (3) anzugeben.
(s. Schild)

CODICE: distinta base
CODE: base list
ART.-Nr.: Basisstückliste

TIPO: descrizione
TYPE: description
TYP: Bezeichnung

RAP: rapporto di riduzione
RATIO: reduction ratio
ÜBERS: Untersetzungsverhältnis

VARIANTE:
codice alfanumerico
MODEL:
alphanumeric code
VARIANTE:
alphanumerische Nummer

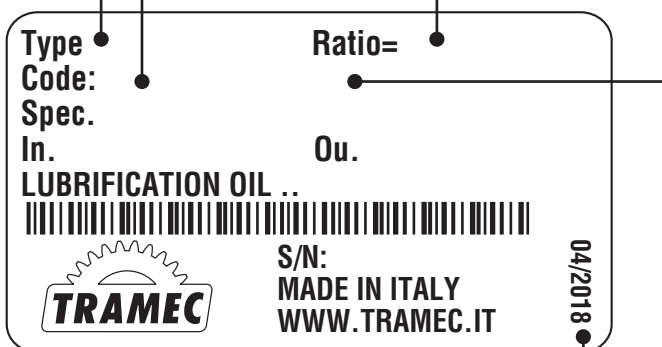

DATA: mese/anno
DATE: month/year
DATUM: Monat/Jahr

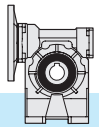

GK

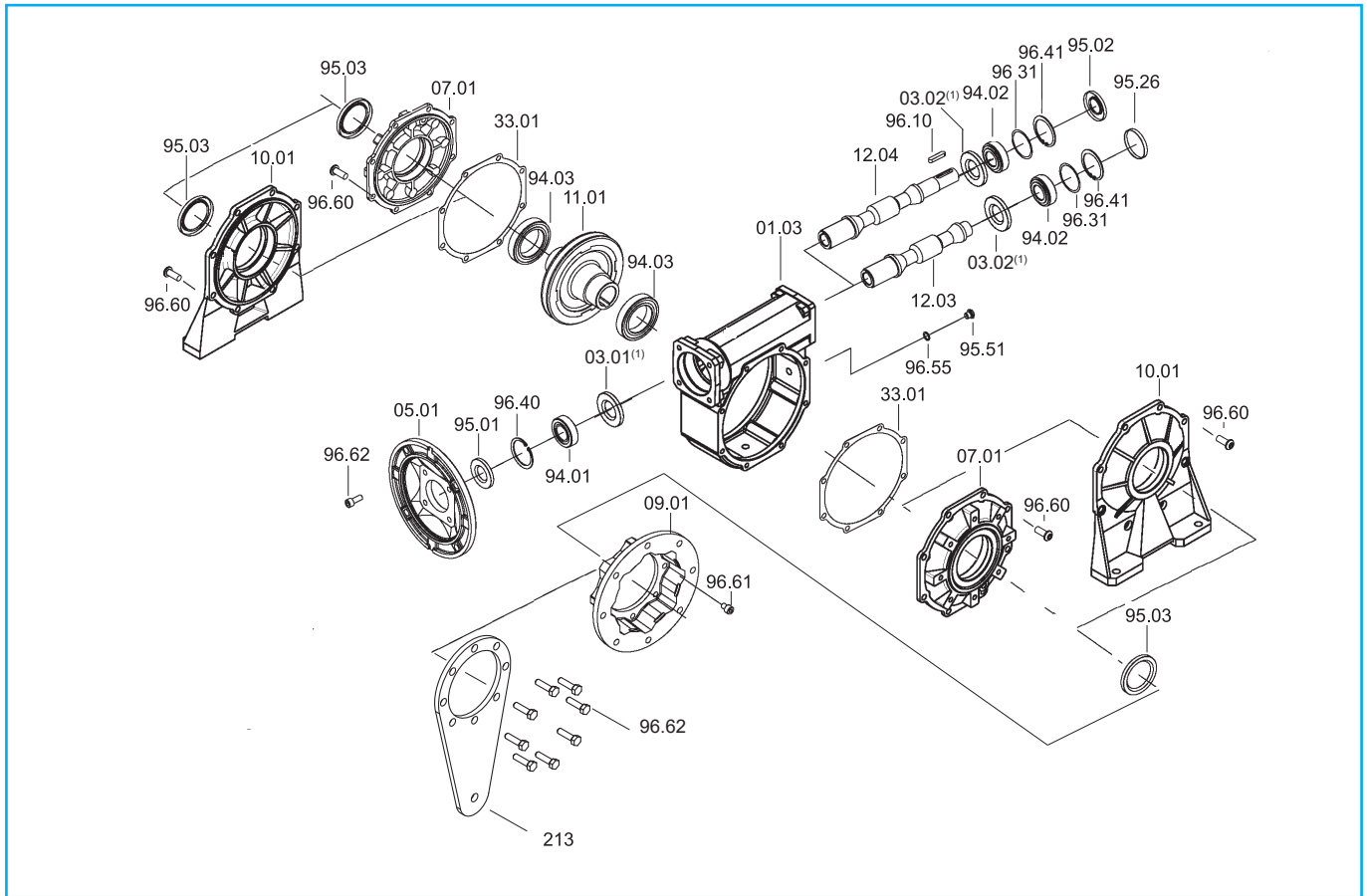

GKC	IEC	Cuscinetti / Bearings / Lager			Anelli di tenuta / Oilseals Öldichtungen			Cappello / Closed oil seal Geschlossene Öldichtung
		94.01	94.02	94.03	95.01	95.02	95.03	95.26
30	56	61804 (20x32x7)	6000 10x26x8	6005 25x47x12	20/32/7	10/26/7	25/40/7	ø 26x7
	63	61804 (20x32x7)			20/32/7			
40	56	6303 (17x47x14)	6201 12x32x10	6006 30x55x13	17/47/7	12/32/7	30/47/7	ø 32x7
	63	6204 (20x47x14)			30x55x17			
	71	6005 (25x47x12)			25/47/7			
50	63	6204 (20x47x14)	6203 17x40x12	6008 40x68x15	20/47/7	17/40/7	40/62/8	ø 40x7
	71	6005 (25x47x12)			25/47/7			
	80	6006 (30x55x13)			30/55/7			
63	71	6305 (25x62x17)	6204 C3 20x47x14	6008 40x68x15	25/62/7	20/47/7	40/62/8	ø 47x7
	80	6206 (30x62x16)			30/62/7			
	90	6007 (35x62x14)			35/62/7			
75	71	6206 (30x62x16)	6205 C3 25x52x15	6010 50x80x16	30/62/7	25/52/7	50/72/8	ø 52x7
	80	6206 (30x62x16)			30/62/7			
	90	6007 (35x62x14)			35/62/7			
	100/112	6008 (40x68x15)			40/68/10			
89	80	6206 (30x62x16)	6205 C3 25x52x15	6010 50x80x16	30/62/7	25/52/7	50/72/8	ø 52x7
	90	6007 (35x62x14)			35/62/7			
	100/112	6008 (40x68x15)			40/68/10			

(1): Solo per GK63, 75, 89 / Only for GK63, 75, 89 / Nur für GK63, 75, 89.

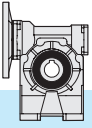

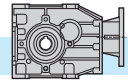

4.0	RIDUTTORE AD ASSI ORTOGONALI GT	BEVEL HELICAL GEARBOX GT	KEGELSTIRNRADGETRIEBE GT
4.1	Caratteristiche	<i>Characteristics</i>	Merkmale 60
4.2	Designazione	<i>Designation</i>	Bezeichnung 61
4.3	Rendimento	<i>Efficiency</i>	Wirkungsgrad 62
4.4	Gioco angolare	<i>Backlash</i>	Winkelspiel 62
4.5	Sensi di rotazione alberi	<i>Direction of shaft rotation</i>	Drehrichtungen der Wellen 62
4.6	Carichi radiali e assiali	<i>Radial and axial loads</i>	Radial- und Axialbelastungen 63
4.7	Lubrificazione	<i>Lubrication</i>	Schmierung 64
4.8	Posizione morsettiera	<i>Terminal board position</i>	Lage des Klemmenkastens 65
4.9	Velocità in entrata	<i>Input speed</i>	Antriebsdrehzahl 65
4.10	Potenza termica	<i>Thermal power</i>	Thermische Leistung 66
4.11	Dati tecnici	<i>Technical data</i>	Technische Daten 67
4.12	Momenti d'inerzia	<i>Moments of inertia</i>	Trägheitsmoment 68
4.13	Dimensioni	<i>Dimensions</i>	Abmessungen 70
4.14	Accessori	<i>Accessories</i>	Zubehör 73
4.15	Lista parti di ricambio	<i>Spare parts list</i>	Ersatzteilliste 71

GHA - CLASSIC

La serie CLASSIC costituisce la serie standard all'interno della gamma di riduttori GHA.

Le speciali caratteristiche NANOTECHNOLOGICHE del rivestimento della carcassa e il suo design esterno, rendono i riduttori di questa serie particolarmente adatti per le applicazioni in ambienti ALIMENTARE e FARMACEUTICO.

Nonostante i riduttori delle serie GHA CLASSIC siano certificati come dispositivi idonei per l'utilizzo su macchine alimentari e dunque per applicazioni che operano in impianti di produzione e di manipolazione degli alimenti, essi non sono certificati per l'utilizzo a contatto con gli alimenti.

GHA - CLASSIC

The CLASSIC series is the standard series within the range of GHA reducers.

The special NANOTECHNOLOGICAL properties of the case coating and its external construction, make the gearboxes of this series particularly suitable for applications in FOOD and PHARMACEUTICAL environments.

Although the GHA CLASSIC series reducers are certified as suitable devices for use on food processing machines and therefore for applications that operate in food production and handling plants, they are not certified for use in contact with food.

GHA - CLASSIC

Die Serie CLASSIC ist die Standardbaureihe innerhalb der Produktpalette der GHA-behandelten Getriebe.

Durch die spezielle NANOTECHNOLOGISCHE Eigenschaften der Gehäusebeschichtung und das Design des Gehäuses sind die Getriebe dieser Serie besonders geeignet für den Einsatz in LEBENSMITTEL- und PHARMAZEUTISCHER Umgebung.

Obwohl die Getriebe der Baureihe GHA CLASSIC als Geräte zertifiziert sind, die für den Einsatz in Lebensmittelmaschinen und damit für Anwendungen in Anlagen zur Produktion und Handhabung von Lebensmitteln geeignet sind, sind sie nicht für den Einsatz in Kontakt mit Lebensmitteln zugelassen.

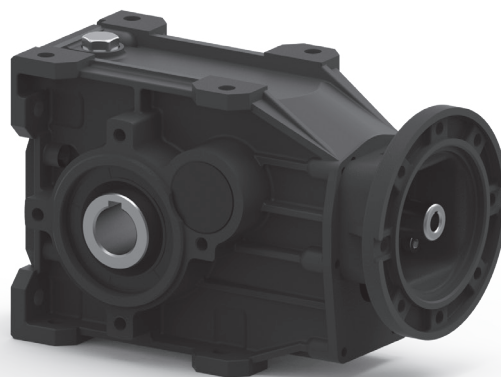

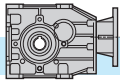

4.1 Caratteristiche

- I riduttori ad assi ortogonali serie GT sono costruiti in 3 grandezze a 2 e a 3 riduzioni.
- Le carcasse e flange in lega di alluminio sono sabbiate e trattate con tecnologia G.H.A.
- È previsto un tipo di entrata: con predisposizione attacco motore (campana e manicotto)
- Il corpo riduttore in lega di alluminio, GAISI9Cu1 UNI7369/3, abbondantemente nervato all'interno e all'esterno per garantire la rigidità, è lavorato su tutti i piani per consentire un facile posizionamento.
- Gli ingranaggi sono costruiti in acciaio legato da cementazione e sottoposti a trattamento di cementazione e tempra. In particolare, la prima riduzione è costituita da due ingranaggi conici ipoidi con profilo accuratamente rodato, in acciaio 16NiCr4 o 18NiCrMo5 cementati e temprati. Gli ingranaggi cilindrici, a dentatura elicoidale, sono costruiti in acciaio 16NiCr4, 18NiCrMo5 o 20MnCr5 UNI EN 10084 cementati e temprati, rettificati entro la classe di qualità 6 della DIN 3962.
- L'albero lento cavo di serie in acciaio INOX AISI 316, la possibilità di montare una flangia uscita su uno o entrambi i fianchi laterali esaltano la versatilità di questi riduttori facilitandone l'installazione.
- Provvisti di bulloneria INOX, tenute in materiale certificato FDA e lubrificanti per l'industria alimentare (categoria di certificazione NSF H1).
- Per applicazioni nel settore marino non si utilizzano lubrificanti NSF H1 e tenute in materiale certificato FDA.

4.1 Characteristics

- *The GT series orthogonal axis reducers are manufactured in 3 sizes with 2 and 3 reductions.*
- *The casings and flanges made of aluminium alloy are sandblasted and treated with G.H.A technology.*
- *One input type available and suitable for the motor mounting (bell and sleeve).*
- *The gear unit casing is in aluminum alloy GAISI9Cu1 UNI7369/3, internally and externally ribbed to guarantee rigidity and it is machined on all surfaces for easy positioning.*
- *The gears are built in casehardened compound steel and have undergone case-hardening and quench-hardening treatments. In particular, the first stage consists of two GLEASON spiral bevel gears with precise ground profile, in 16NiCr4 or 18NiCrMo5 case hardened and quench-hardened steel. The helical spur gears are built in 16NiCr4, 18NiCrMo5 or 20MnCr5 UNI EN 10084, quench – hardened and case-hardened steel, ground according and within Class 6 quality DIN 3962.*
- *The Stainless Steel AISI 316 hollow shaft together with the possibility to mount an output flange on one or both sides, enhance the versatility of these gearboxes, making it easy to install.*
- *Equipped with stainless steel nuts and bolts, seals made of FDA-certified material and lubricants for the food industry (NSF H1 certification category).*
- *For applications in the marine sector, NSF H1 lubricants and FDA-certified seals are not used.*

4.1 Merkmale

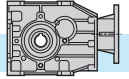

- Die Kegelstirnradgetriebe der Serie GT werden in 3 Baugrößen mit 2 und mit 3 Untersetzungen hergestellt.
- Die Gehäuse und die Flansche aus Aluminiumlegierung sind sandgestrahlt und mit G.H.A.-Technologie hergestellt.
- Grundauführung mit freier Eintriebswelle; Motoranbau via Glocke und Kupplung
- Das Getriebegehäuse besteht aus einer Aluminium Legierung (GAISI-9Cu1 UNI7369/3) und ist mit Rippen versehen, die die gewünschte Steifheit garantieren. Die Bearbeitung aller Oberflächen ermöglicht eine exakte Positionierung.
- Die Zahnräder bestehen aus gehärtetem Stahl und sind zusätzlich oberflächengehärtet. Die erste Stufe besteht aus zwei spiralverzahnten GLEASON – Kegelrädern in 16NiCr4 oder 18NiCr5. Die Stirnradstufen sind schrägverzahnt und in 16NiCr4, 18NiCrMo5 oder 20MnCr5 UNI EN 10084 in der Qualitäts-Klasse 6 DIN 3962 ausgeführt.
- Die rostfreie Edelstahl-Hohlwelle AISI 316, mit der Möglichkeit, Ausgangsflansche an einer oder beiden Seiten zu montieren, erhöht die Vielseitigkeit der Getriebe und erleichtert die Montage.
- Ausgestattet mit Edelstahlschrauben, Dichtungen aus FDA-zertifiziertem Material und Schmierstoffen für die Lebensmittelindustrie (Zertifizierungskategorie NSF H1).
- Für Anwendungen im Schifffahrtsbereich werden keine NSF H1-Schmierstoffe und Dichtungen aus FDA-zertifiziertem Material verwendet.



4.2 Designazione

4.2 Designation

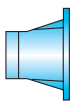
4.2 Bezeichnung

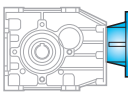
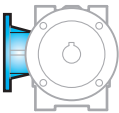
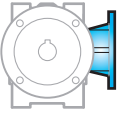
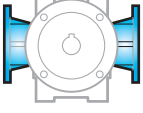
Riduttore Gearbox Getriebe	Tipo entrata Input type Antriebsart	Grandezza Size Größe	Rotismo Gearing Räderwerk	Rapporto rid. Ratio Untersetzungsverhältnis	Predisposiz. Motor coupling Motoranschluss	Esecuzione Execution Ausführung	Posizione di montaggio Mounting position Baulage	Albero uscita cavo Hollow output shaft Abtriebshohlwelle	Flangia uscita Output flange Abtriebsflansch	Campo di applicazione Field of application Anwendungsbereich
GT	F	63	B	10	P.A.M.	O	B3	25	FLS	A
Riduttore ad assi ortogonali Bevel helical gearbox Kegelstirnradgetriebe		56 63 75	 	$i_n = 8 \div 315$	56 ÷ 100		B3 B6 B7 B8 VA VB	v. pag. dimensioni See page dimensions siehe Seite Abmessungen	 FLS  FLD  FL2	A Alimentare e Farmaceutico Food and Pharmaceutical Lebensmittel- und Pharmaindustrie M* Marino Marine Schifffahrt

*: a richiesta

*: on request

*: auf Anfrage

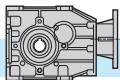

4.3 Rendimento

Il valore del rendimento dei riduttori può essere stimato con sufficiente approssimazione in base al numero di riduzioni, trascurando le variazioni non significative attribuibili alle varie grandezze e rapporti.

4.3 Efficiency

The efficiency value of the gear units can be estimated sufficiently well on the basis of the number of reduction stages, ignoring non-significant variations which can be attributed to the various sizes and ratios.

4.3 Wirkungsgrad

Der Wirkungsgrad des Getriebes kann mit ausreichender Annäherung aufgrund der Anzahl der Untersetzungsstufen ermittelt werden. Dabei können die unwesentlichen Veränderungen, die auf die verschiedenen Grössen und Untersetzungsverhältnisse zurückzuführen sind, ausser Acht gelassen werden.

η	GTF..B	GTF..C
	0.95	0.93

4.4 Gioco angolare

Misurato bloccando l'albero entrata, e ruotando l'albero uscita nelle due direzioni applicando la coppia strettamente necessaria a creare il contatto tra i denti degli ingranaggi, al massimo pari al 2% della coppia nominale (T_{2M}).

4.4 Backlash

Angular backlash measured after having blocked the input shaft by rotating output shaft in both directions and applying the torque which is strictly necessary to create a contact between the teeth of the gears. The applied torque should be at most 2% of the max. torque (T_{2M}).

4.4 Winkelspiel

Nachdem die Antriebswelle blockiert worden ist, darf das Winkelspiel auf die Abtriebswelle bemessen werden. Dabei soll die Antriebswelle in beiden Richtungen gedreht werden und ein Drehmoment ausgeübt werden, das zur Entstehen eines Kontaktes zwischen den Zähnen genuegt. Das ausgeübte Drehmoment soll höchstens 2% des max. von Getrieben garantierten Drehmoment (T_{2M}) sein.

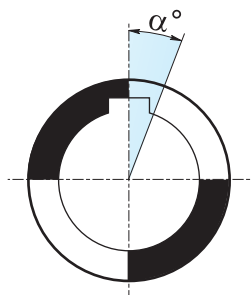

	GT	
	Gioco angolare massimo Maximum Backlash maximales Winkelspiel	
2 stadi/stages/stufig	20'	
3 stadi/stages/stufig	20'	

4.5 Senso di rotazione

4.5 Direction of rotation

4.5 Drehrichtung

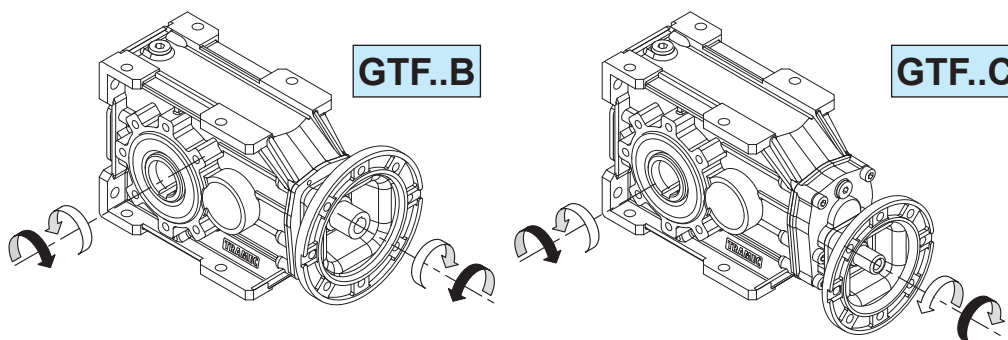

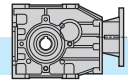

4.6 Carichi radiali

Carichi radiali Fr_2 e assiali Fa_2 sull'albero uscita [N]

Se il carico radiale sull'albero non è applicato a metà della sporgenza dell'albero, il valore del carico ammissibile deve essere valutato utilizzando la formula che si riferisce ad Fry_2 , in cui i valori di a , b e Fr_2 sono riportati nelle tabelle relative ai carichi radiali.

Nel caso di alberi bisporgenti il valore del carico applicabile a ciascuna estremità è uguale ai 2/3 del valore di tabella, purché i carichi applicati siano uguali di intensità e direzione ed agiscano nello stesso senso. Diversamente contattare il servizio tecnico.

4.6 Radial load

Fr_2 radial loads and Fa_2 axial loads on the output shaft [N]

Should the radial load affect the shaft not at the half-way point of its projection but at a different point, the value of the admissible load has to be calculated using the Fry_2 formula: a , b and Fr_2 values are reported in the radial load tables.

With regard to double-projecting shafts, the load applicable at each end is 2/3 of the value given in the table, on condition that the applied loads feature same intensity and direction and that they act in the same direction.

Otherwise please contact the technical department.

4.6 Radialbelastungen

Fr_2 Radialbelastungen und Fa_2 Axialbelastungen auf die Abtriebswelle [N]

Falls die Radialbelastungen nicht in dem Mittelpunkt der herausragenden Welle sondern in einem anderen Punkt wirken, soll die zulässige Belastung mit der Formel bezüglich Fry_2 kalkuliert werden: a , b und Fr_2 Werte sind aus der Tabelle der Radialbelastungen zu entnehmen.

Bei doppelseitigen Abtriebswellen ist die Belastung, die an jedem Ende anwendbar ist, 2/3 des in der Tabelle angegebenen Wertes unter der Bedingung, dass die Belastungen die selbe Stärke und Richtung aufweisen und dass sie in der selben Richtung wirken. Andernfalls muß mit dem technischen Büro Rücksprache gehalten werden.

I carichi radiali indicati nelle tabelle si intendono applicati a metà della sporgenza dell'albero e sono riferiti ai riduttori operanti con fattore di servizio 1.

The radial loads indicated in the chart are considered to be applied at the half-way point of the shaft projection, and refer to gear units operating with service factor 1.

Die Radialbelastungen, die in den Tabellen angegeben werden, gelten für Ansatzpunkte in der Mitte des herausragenden Wellenteils und für Getriebe mit Betriebsfaktor 1.

		GT 56B		GT 63B		GT 75B				GT 56C		GT 63C		GT 75C			
ALBERO USCITA / OUTPUT SHAFT / ABTRIEBSWELLE ($n_1 = 1400 \text{ min}^{-1}$)																	
in	a = 106		b = 81		a = 121		b = 93.5		in	a = 106		b = 81		a = 121		b = 93.5	
	Fr_2	Fa_2	Fr_2	Fa_2	Fr_2	Fa_2	Fr_2	Fa_2		Fr_2	Fa_2	Fr_2	Fa_2	Fr_2	Fa_2		
8	1300	260	1500	300	2500	500	40	2300	460	2500	500	—	—	—	—		
10	1300	260	1500	300	2500	500	50	2300	460	2500	500	3500	700	3500	700		
12.5	1300	260	1500	300	2500	500	63	2300	460	2500	500	3500	700	3500	700		
16	1800	360	2000	400	2500	500	80	2800	560	3000	600	3500	700	3500	700		
20	1800	360	2000	400	3000	600	100	2800	560	3000	600	4000	800	4000	800		
25	1800	360	2000	400	3000	600	125	2800	560	3000	600	4000	800	4000	800		
31.5	1800	360	2000	400	3000	600	160	2800	560	3000	600	4000	800	4000	800		
40	2300	460	2500	500	3500	700	200	3000	600	3500	700	4500	900	4500	900		
50	2300	460	2500	500	3500	700	250	3000	600	3500	700	4500	900	4500	900		
63	—	—	2500	500	—	—	315	—	—	3500	700	—	—	—	—		

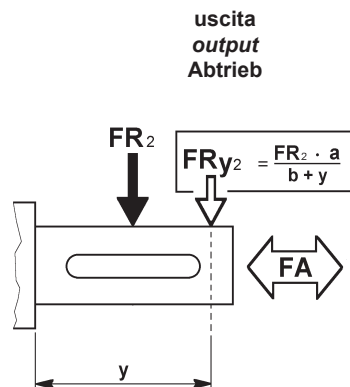

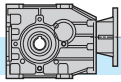

4.7 Lubrificazione

I riduttori ad assi ortogonali GTF56, GTF63 e GTF75 sono lubrificati a vita con olio alimentare OLIO FUCHS CASSIDA FLUID 320. Il grasso lubrificante applicato sui cuscinetti è compatibile con uso alimentare ed è il FUCHS CASSIDA GREASE HTS2.

Si raccomanda di precisare sempre la posizione di montaggio desiderata in fase di ordine.

Per ulteriori dettagli consultare pag. 17 paragrafo 1.6

Nelle posizioni di montaggio in cui sono presenti cuscinetti posti al di sopra del livello dell'olio lubrificante è prevista l'applicazione di grasso speciale su tali cuscinetti per migliorarne la lubrificazione. E' possibile dotare gli stessi cuscinetti di un anello metallico (nylos) con la funzione di contenimento del grasso e, di conseguenza, di prolungare l'effetto nel tempo. Questa soluzione viene fornita su specifica richiesta.

Posizione di montaggio e quantità di lubrificante (litri)

I quantitativi di olio riportati nelle varie tabelle sono indicativi e riferiti alle posizioni di lavoro indicate e considerando le condizioni di funzionamento a temperatura ambiente e velocità in ingresso di 1400 min⁻¹. Per condizioni di lavoro diverse da quelle sopra riportate contattare il servizio tecnico.

4.7 Lubrication

Bevel helical gearboxes type GTF56, GTF63 and GTF75 are lubricated for life with FUCHS CASSIDA FLUID 320 oil. The grease FUCHS CASSIDA GREASE HTS2 applied on the bearings is compatible with food use.

It is recommended to always specify the desired assembly position when placing the order.

For further details, please see page 17 paragraph 1.6

Depending on the mounting position the bearings may be lodged above the lubricant level. In this case, it is necessary to apply special grease on the bearings to improve their lubrication. A metallic ring (nylos-ring) can be fitted on the bearings, it keeps the grease in place thus prolonging the action. It is supplied on specific request.

Mounting positions and lubricant quantity (liters)

The oil quantities stated in the tables are approximate values and refer to the indicated working positions, considering operating conditions at ambient temperature and an input speed of 1400 min⁻¹. Should the operating conditions be different, please contact the technical service.

4.7 Schmierung

Die Kegelstirnradgetriebe Typ GTF56, GTF63 und GTF75 werden mit FUCHS CASSIDA FLUID 320 Öl geschmiert. Das auf die Lager aufgebrauchte Fett, FUCHS CASSIDA GREASE HTS2, ist geeignet für den Einsatz in der Lebensmittelindustrie.

Es wird empfohlen, bei der Bestellung immer die gewünschte Einbaulage anzugeben.

Für weitere Details siehe Seite 17, Absatz 1.6.

Abhängig von der Einbaulage kann es sein, dass die Lager über dem Ölstand liegen. In diesem Fall wird Sonderfett auf die Lager aufgetragen, um deren Schmierung zu gewährleisten. Auf Wunsch kann ein Metallring (Nilos – Ring) für die Lager geliefert werden. Dieser hält das Fett im Lager und verlängert die Lebensdauer.

Montageposition und Ölmenge (liter)

Die in der Tabellen angegebenen Daten sind Richtwerte. Die Ölmengen beziehen sich auf die angegebenen Betriebspositionen. Dabei wird den Betrieb bei Umgebungstemperatur und Antriebsdrehzahl von 1400 min⁻¹ berücksichtigt. Falls die Betriebsbedingungen anders sind, dann ist das technische Büro zu befragen.

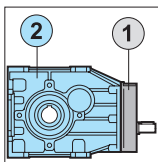
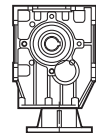
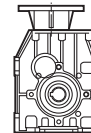
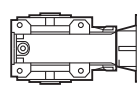
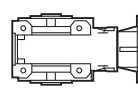
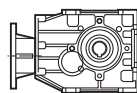
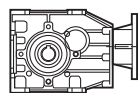

	GT	B3	B8	B6	B7	VA	VB
②	56B		0.30			0.40	0.30
①	56C			0.05			
②	56C		0.30			0.40	0.30
②	63B		0.35			0.45	0.35
①	63C			0.05			
②	63C		0.35			0.45	0.35
②	75B			0.45			
①	75C			0.08			
②	75C			0.45			

* Nella posizione di montaggio B6-B7 è previsto un tappo di sfiato con asta di livello.

* In mounting position B6-B7 the breather plug is supplied complete with the dipstick.

* Für die Version B6-B7 ist eine Entlüftungsschraube mit Ölstandsanzeige vorgesehen.

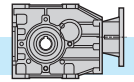

4.8 Posizione morsettiera

4.8 Terminal board position

4.8 Lage des Klemmenkastens

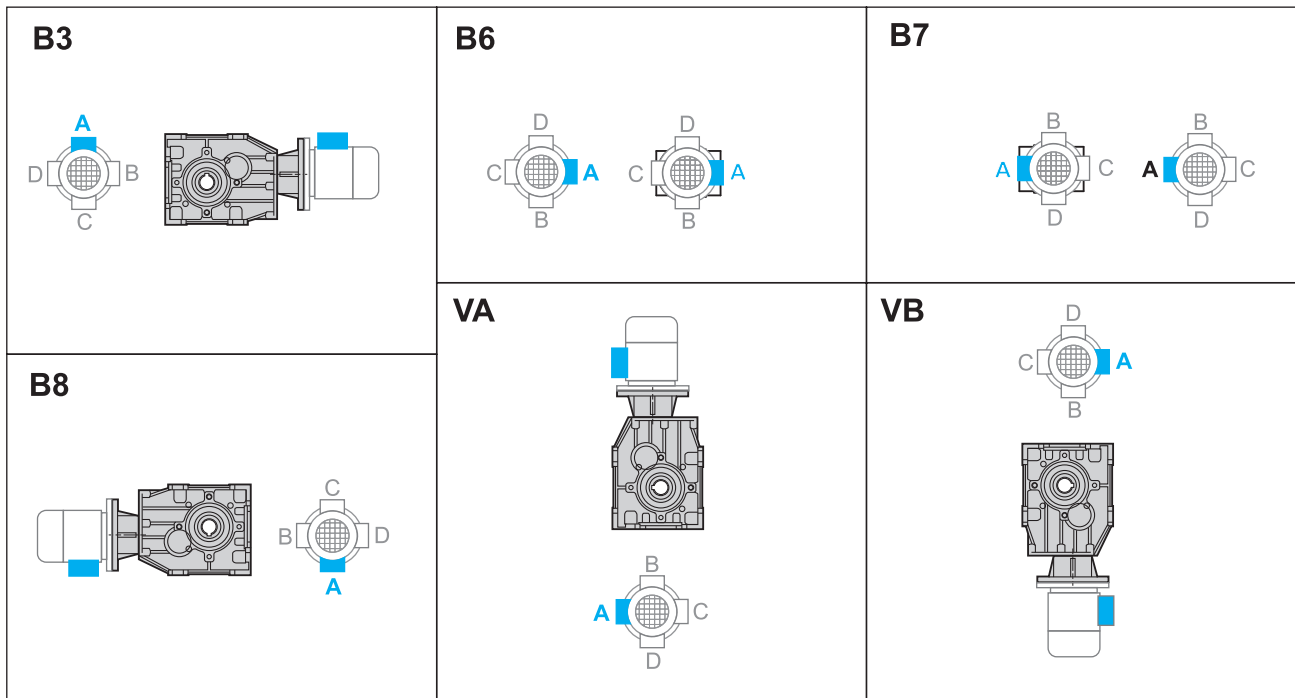

Specificare sempre in fase di ordinazione la posizione di montaggio e la forma costruttiva.

Mounting position always to be specified when ordering.

Bei der Bestellung immer die gewünschte Montageposition und Bauform angeben.

4.9 Velocità in entrata

Tutte le prestazioni dei riduttori sono calcolate in base ad una velocità in entrata di 1400 min⁻¹.

Tutti i riduttori ammettono velocità fino a 3000 min⁻¹ anche se è consigliabile, dove l'applicazione lo permette, utilizzare valori inferiori a 1400 min⁻¹.

Nella tabella sottostante riportiamo i coefficienti correttivi della potenza in entrata P alle varie velocità riferita ad Fs = 1

4.9 Input speed

All calculations of gear unit performance are based on an input speed of 1400 min⁻¹. All gear units permit speed up to 3000 min⁻¹, nevertheless it is advisable to keep below 1400 min⁻¹, depending on application.

The table below reports input power P corrective coefficients at the various speeds, with Fs = 1.

4.9 Antriebsdrehzahl

Bei der Berechnung der Getriebeleistungen wurde eine Antriebsdrehzahl von 1400 min⁻¹ berücksichtigt.

Bei allen Getrieben sind Antriebsdrehzahlen bis 3000 min⁻¹ möglich; es ist jedoch ratsam, die Drehzahlen unter 1400 min⁻¹ zu halten, wenn die Anwendung es ermöglicht.

In der folgenden Tabelle finden Sie die Korrekturkoeffizienten für die Antriebsleistung P bei den verschiedenen Drehzahlen, bezogen auf Fs = 1.

Tab. 1

n ₁ (rpm)	3000	2800	2200	1800	1400	900	700	500
P _c (kW)	P x 1.9	P x 1.8	P x 1.48	P x 1.24	P x 1	P x 0.7	P x 0.56	P x 0.42

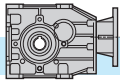

4.10 Potenza termica

I valori delle potenze termiche, P_{10} (kW), sono riportati nella tabella seguente, in funzione di grandezza, rapporto e velocità entrata del riduttore.
I valori sono calcolati considerando l'utilizzo di olio sintetico ISO 320.
Vedere paragrafo 1.4 per la scelta dei fattori correttivi.

4.10 Thermal power

The following table shows the values of thermal power P_{10} (kW) for each gearbox size on the basis of ratio and input speed. The values have been calculated considering the utilization of synthetic oil ISO 320. See chapter 1.4 for the corrective coefficients.

4.10 Thermische Leistung

Die folgende Tabelle enthält die Werte P_{10} der thermischen Leistung (kW) je nach Getriebegröße und abhängig von Untersetzung und von Drehzahlen am Getriebeantrieb. Die angegebenen Werte beziehen sich auf Schmierung mit synthetischen Öl ISO 320.
Im Abschnitt 1.4 finden Sie die Korrekturkoeffizienten.

Potenza Termica / Thermal power / Thermische Leistung P_{10} [kW]						
	GTF56B		GTF63B		GTF75B	
i_n	1400	2800	1400	2800	1400	2800
8						
10						
12.5						
16						
20	4	3.4	5.5	4.7	5.6	4.8
25						
31.5						
40						
50						
63	-	-	-	-	-	-
80						

Potenza Termica / Thermal power / Thermische Leistung P_{10} [kW]						
	GTF56C		GTF63C		GTF75C	
i_n	1400	2800	1400	2800	1400	2800
40					-	-
50						
63						
80						
100	3.3	2.8	4.2	3.6	4.3	3.7
125						
160						
200						
250						
315						
400	-	-	-	-	-	-
500						
630						

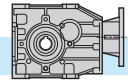

4.11 Dati tecnici

4.11 Technical data

4.11 Technische Daten

GT	n ₁ = 1400			MOTORI / MOTORS / ENGINE GHA CLASSIC			
	in	ir	n ₂ rpm	T ₂ Nm	P1 kW	FS'	IEC
56B	8	8.06	174	94	1.8	1.2	56
	10	10.17	138	120	1.8	1.0	63
	12.5	12.31	114	120	1.5	1.1	(B5)
	16	15.00	93	107	1.1	1.3	71
	20	20.33	69	140	1.1	1.0	80
	25	24.62	57	140	0.9	1.0	90
	31.5	30.00	47	107	0.55	1.3	(B5)
	40	39.38	36	140	0.55	1.0	(B14)
	50	48.00	29	115	0.37	1.2	TF
56C	40	40.28	35	140	0.55	1.0	56
	50	50.83	28	119	0.37	1.2	63
	63	61.54	23	140	0.37	1.0	(B5)
	80	75.00	19	119	0.25	1.2	71
	100	101.67	14	145	0.22	1.0	80
	125	123.08	11	141	0.18	1.0	90
	160	150.00	9	124	0.13	1.2	(B5)
	200	196.92	7	136	0.11	1.1	(B14)
	250	240.00	6	135	0.09	1.0	TF
63B	8	7.94	176	93	1.8	1.7	56
	10	10.18	138	119	1.8	1.4	63
	12.5	12.50	112	146	1.8	1.3	(B5)
	16	15.88	88	185	1.8	1.0	71
	20	20.36	69	200	1.5	1.0	80
	25	25.00	56	180	1.1	1.1	90
	31.5	31.00	45	181	0.9	1.1	(B5)
	40	40.00	35	194	0.75	1.0	(B14)
	50	49.60	28	177	0.55	1.0	TF
	63	60.80	23	146	0.37	1.0	TF
63C	40	39.71	35	194	0.75	1.0	56
	50	50.89	28	178	0.55	1.2	63
	63	62.50	22	210	0.55	1.0	(B5)
	80	79.41	18	186	0.37	1.1	71
	100	101.79	14	161	0.25	1.3	80
	125	125.00	11	198	0.25	1.0	90
	160	155.00	9	210	0.22	1.0	(B5)
	200	200.00	7	165	0.13	1.3	(B14)
	250	248.00	6	200	0.13	1.0	TF
	315	304.00	5	180	0.09	1.0	TF
75B	8	7.87	178	204	4.0	1.2	71
	10	9.82	143	254	4.0	1.1	80
	12.5	12.67	110	330	4.0	1.0	90
	16	15.43	91	299	3.0	1.1	100
	20	19.38	72	277	2.2	1.3	112
	25	25.00	56	356	2.2	1.0	(B5)
	31.5	30.45	46	355	1.8	1.1	(B14)
	40	40.00	35	285	1.1	1.3	TF
	50	48.73	29	344	1.1	1.1	TF
75C	50	49.08	29	330	1.1	1.0	63
	63	63.33	22	303	0.75	1.1	(B5)
	80	77.15	18	271	0.55	1.3	71
	100	96.88	14	350	0.55	1.0	80
	125	125.00	11	299	0.37	1.2	90
	160	152.27	9	247	0.25	1.4	(B5)
	200	200.00	7	317	0.25	1.2	(B14)
	250	243.64	6	370	0.25	1.0	TF

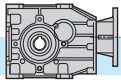

4.12 **Momenti d'inerzia** [Kg·cm²]
(riferiti all'albero veloce in entrata)

4.12 **Moments of inertia** [Kg·cm²]
(referred to input shaft)

4.12 **Trägheitsmoment** [Kg·cm²]
(bez. Antriebswelle)

GTF..B

56B	i _n	GTF				
		IEC B5				
		56	63	71	80	90
8			0.32	0.40	0.60	0.77
10	0.29	0.29	0.37	0.56	0.74	
12.5	0.27	0.27	0.35	0.54	0.72	
16	0.25	0.26	0.33	0.53	0.71	
20	0.15	0.15	0.22	0.42	0.60	
25	0.14	0.15	0.22	0.42	0.59	
31.5	0.14	0.14	0.21	0.41	0.59	
40	0.11	0.12	0.19	0.39	0.56	
50	0.11	0.11	0.19	0.39	0.56	

63B	i _n	GTF				
		IEC B5				
		56	63	71	80	90
8	0.47	0.47	0.55	0.74	0.92	
10	0.41	0.42	0.49	0.69	0.87	
12.5	0.38	0.38	0.45	0.65	0.83	
16	0.23	0.24	0.31	0.51	0.68	
20	0.22	0.22	0.29	0.49	0.67	
25	0.21	0.21	0.29	0.48	0.66	
31.5	0.20	0.21	0.28	0.48	0.65	
40	0.15	0.15	0.22	0.42	0.60	
50	0.14	0.15	0.22	0.42	0.60	
63	0.14	0.15	0.22	0.42	0.59	

75B	i _n	GTF			
		IEC B5			
		71	80	90	100-112
8	1.70	2.10	2.01	3.05	
10	1.55	1.96	1.87	2.91	
12.5	1.39	1.80	1.71	2.75	
16	1.34	1.74	1.65	2.69	
20	0.71	1.11	1.02	2.06	
25	0.67	1.07	0.98	2.02	
31.5	0.65	1.06	0.97	2.01	
40	0.51	0.92	0.82	1.86	
50	0.50	0.91	0.82	1.86	

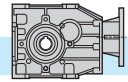

4.12 **Momenti d'inerzia** [Kg·cm²]
(riferiti all'albero veloce in entrata)

4.12 **Moments of inertia** [Kg·cm²]
(referred to input shaft)

4.12 **Trägheitsmoment** [Kg·cm²]
(bez. Antriebswelle)

GTF..C

56C	i_n	GTF				
		IEC B5				
		56	63	71	80	90
40	0.136	0.139	0.212	0.410	0.588	
50	0.134	0.138	0.211	0.409	0.587	
63	0.134	0.137	0.210	0.408	0.586	
80	0.133	0.137	0.210	0.408	0.585	
100	0.129	0.132	0.205	0.403	0.581	
125	0.129	0.132	0.205	0.403	0.581	
160	0.128	0.132	0.205	0.403	0.581	
200	0.127	0.131	0.204	0.402	0.580	
250	0.127	0.131	0.204	0.402	0.580	

63C	i_n	GTF				
		IEC B5				
		56	63	71	80	90
40	0.142	0.145	0.218	0.416	0.594	
50	0.139	0.143	0.216	0.414	0.592	
63	0.138	0.142	0.215	0.413	0.590	
80	0.132	0.136	0.209	0.407	0.585	
100	0.132	0.135	0.208	0.406	0.584	
125	0.131	0.135	0.208	0.406	0.584	
160	0.131	0.135	0.208	0.406	0.583	
200	0.129	0.132	0.205	0.403	0.581	
250	0.129	0.132	0.205	0.403	0.581	
315	0.129	0.132	0.205	0.403	0.581	

75C	i_n	GTF			
		IEC B5			
		63	71	80	90
50	0.179	0.252	0.450	0.628	
63	0.173	0.246	0.444	0.622	
80	0.171	0.244	0.442	0.619	
100	0.145	0.219	0.417	0.594	
125	0.144	0.217	0.415	0.593	
160	0.143	0.216	0.414	0.592	
200	0.138	0.211	0.409	0.586	
250	0.137	0.210	0.408	0.586	

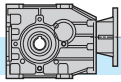

4.13 Dimensioni

4.13 Dimensions

4.13 Abmessungen

GTF56B...

2 Riduzioni/Stages/Stufen

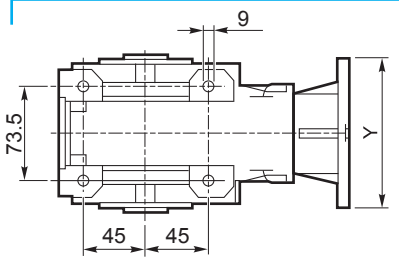

GTF56C...

3 Riduzioni/Stages/Stufen

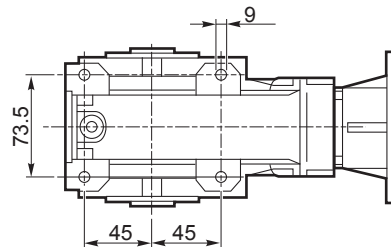
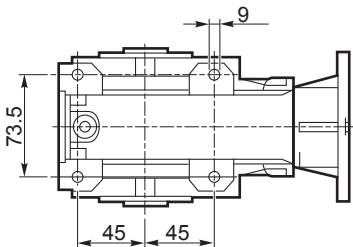
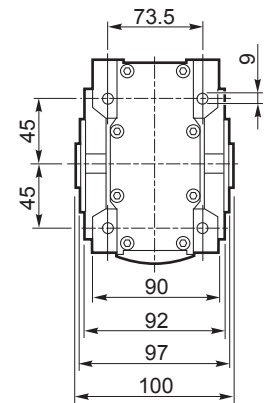
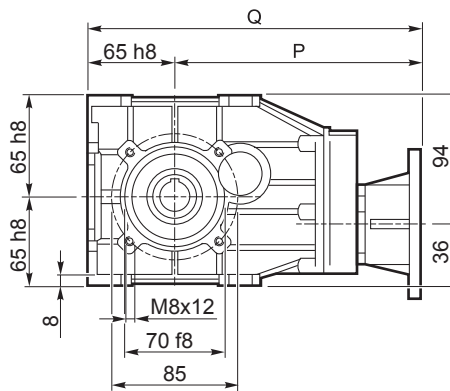
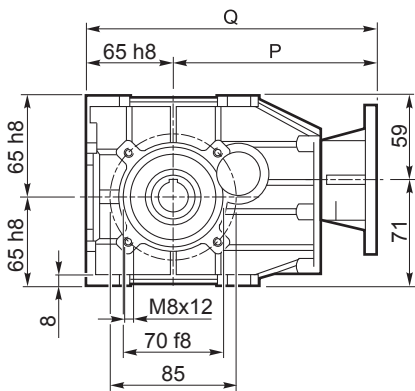
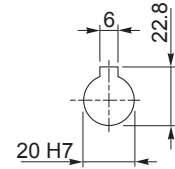
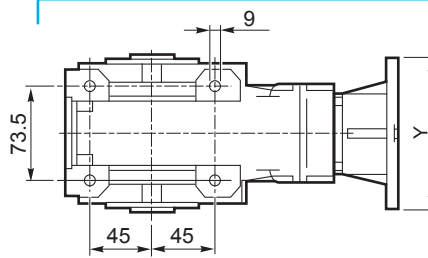

IEC	
	56 B5
	63 B5
	71 B5
	80 B5/B14
	90 B5/B14

B5	GTF...									
	56B					56C				
IEC..	56	63	71	80	90	56	63	71	80	90
Y	120	140	160	200	200	120	140	160	200	200
P	153	156	163	183	183	187	190	197	217	217
Q	218	221	228	248	248	252	255	262	282	282
kg	4.5	4.5	4.5	4.5	4.5	5.0	5.0	5.0	5.0	5.0

B14	GTF...									
	56B					56C				
IEC..	56	63	71	80	90	56	63	71	80	90
Y	—	—	105	120	140	—	—	105	120	140
P	—	—	163	183	183	—	—	197	217	217
Q	—	—	228	248	248	—	—	262	282	282
kg	—	—	4.5	4.5	4.5	—	—	5.0	5.0	5.0

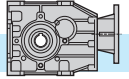

4.13 Dimensioni

4.13 Dimensions

4.13 Abmessungen

GTF63B...

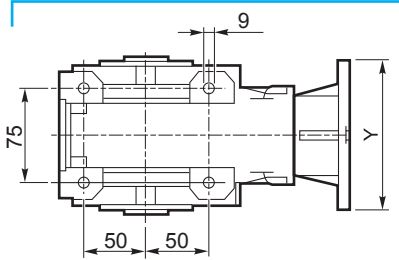

2 Riduzioni/Stages/Stufen

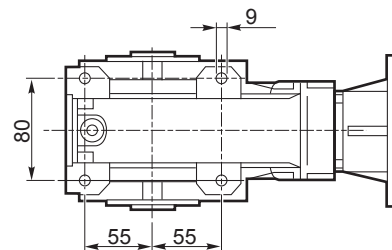
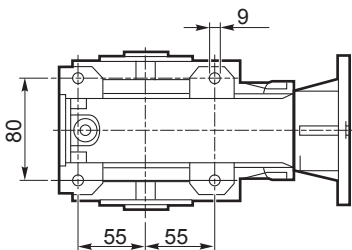
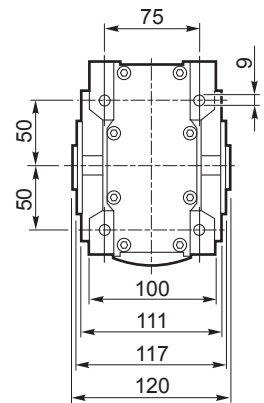
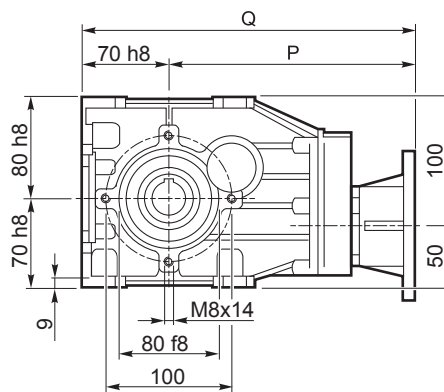
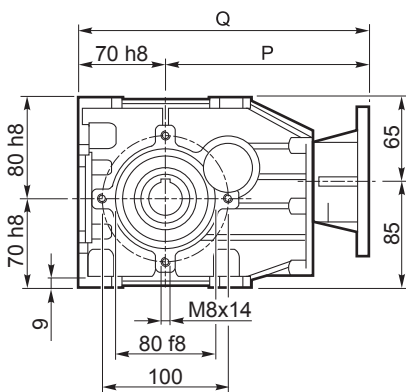
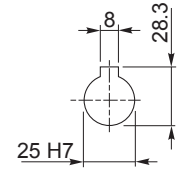
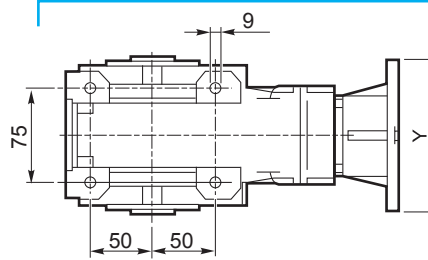

GTF63C...

3 Riduzioni/Stages/Stufen



IEC	
	56 B5
	63 B5
71 B14	71 B5
	80 B5/B14
	90 B5/B14

B5	GTF...									
	63B					63C				
IEC..	56	63	71	80	90	56	63	71	80	90
Y	120	140	160	200	200	120	140	160	200	200
P	160	163	170	190	190	194	197	204	224	224
Q	230	233	240	260	260	264	267	274	294	294
kg	6.0	6.0	6.0	6.0	6.0	6.5	6.5	6.5	6.5	6.5

B14	GTF...									
	63B					63C				
IEC..	56	63	71	80	90	56	63	71	80	90
Y	—	—	105	120	140	—	—	105	120	140
P	—	—	170	190	190	—	—	204	224	224
Q	—	—	240	260	260	—	—	274	294	294
kg	—	—	6.0	6.0	6.0	—	—	6.5	6.5	6.5

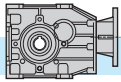

4.13 Dimensioni

4.13 Dimensions

4.13 Abmessungen

GTF75B...

GTF75C...

2 Riduzioni/Stages/Stufen

3 Riduzioni/Stages/Stufen

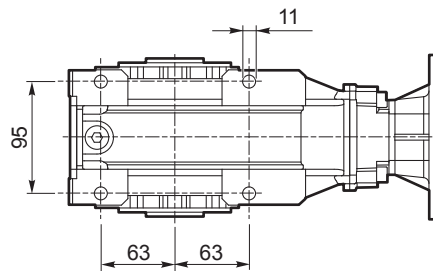
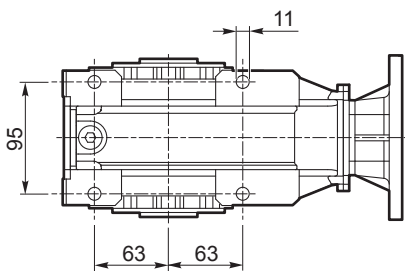
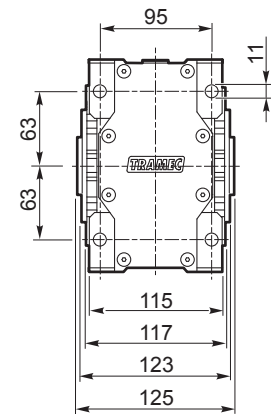
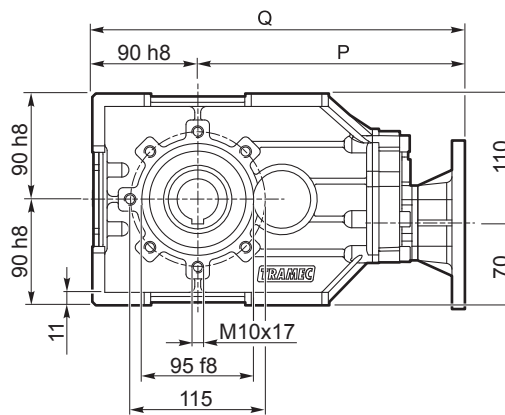
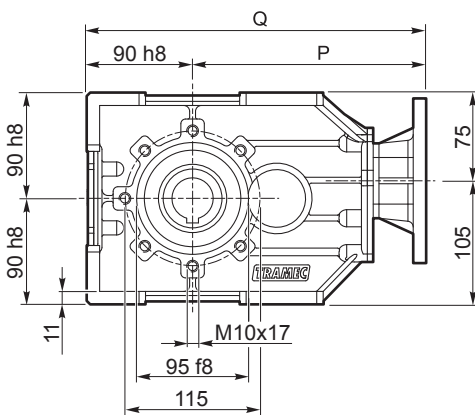
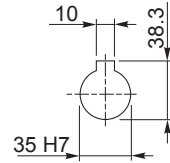
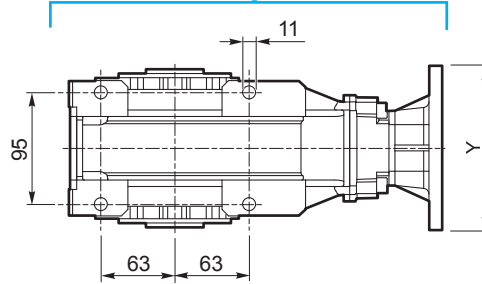
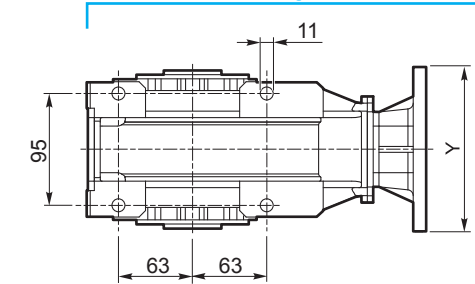

IEC	
	63 B5
	71 B5
	80 B5/B14
	90 B5/B14
	100 B5/B14

B5	GTF...									
	75B					75C				
IEC..	71	80	90	100	112	63	71	80	90	
Y	160	200	200	250	250	140	160	200	200	
P	205.5	225.5	225.5	235.5	235.5	227	234	254	254	
Q	295.5	315.5	315.5	325.5	325.5	317	324	344	344	
kg	6.5	6.5	6.5	6.5	6.5	7	7	7	7	

B14	GTF...									
	75B					75C				
IEC..	71	80	90	100	112	63	71	80	90	
Y	105	120	140	160	160	-	105	120	140	
P	205.5	225.5	225.5	235.5	235.5	-	234	254	254	
Q	295.5	315.5	315.5	325.5	325.5	-	324	344	344	
kg	6.5	6.5	6.5	6.5	6.5	7	7	7	7	

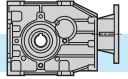

4.14 Accessori

4.14 Accessories

4.14 Zubehör

Flangia uscita

Output flange

Abtriebsflansch

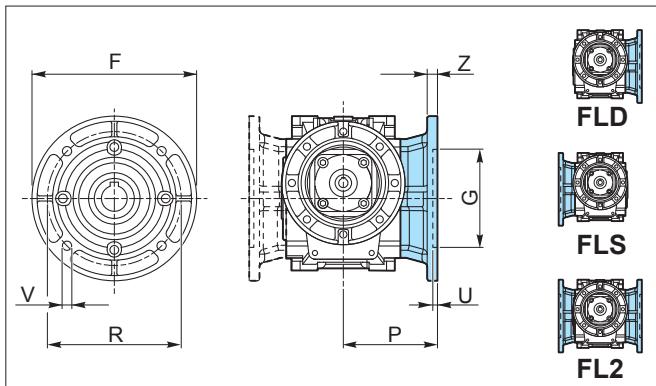

	GT		
	56B 56C	63B 63C	75B 75C
F	140	160	200
G_{F7}	95	110	130
R	115	130	165
P	82	91.5	97.5
U	5	5	5
V	9	9	12
Z	15	10	15
kg	0.5	0.5	0.9

4.15 Lista parti di ricambio

4.15 Spare parts list

4.15 Ersatzteilliste

In fase di ordine delle parti di ricambio, specificare sempre n° particolare (vedi disegno esploso), data (1), n° codice (2) e n° variante (3). (Vedi targhetta).

When ordering please specify the spare part number (see exploded view) as well as the date (1), the article number (2) and the variant number (3) (see plate)

Bei der Bestellung von Ersatzteilen sind Ersatzteilnummer (s. Explosionszeichnung), Datum (1), Artikelnummer (2) und Variantennummer (3) anzugeben. (s. Schild)

CODICE: distinta base
CODE: base list
ART.-Nr.: Basisstückliste

TIPO: descrizione
TYPE: description
TYP: Bezeichnung

RAP: rapporto di riduzione
RATIO: reduction ratio
ÜBERS: Untersetzungsverhältnis

VARIANTE:
codice alfanumerico
MODEL:
alphanumeric code
VARIANTE:
alphanumerische Nummer

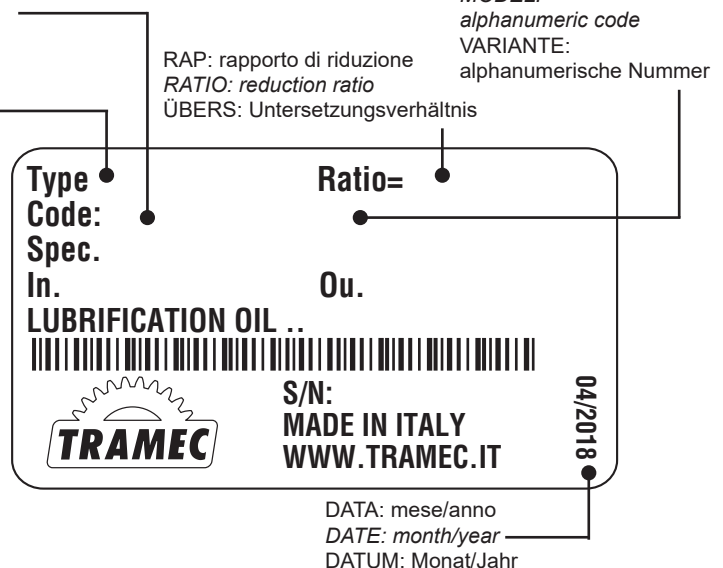

DATA: mese/anno
DATE: month/year
DATUM: Monat/Jahr

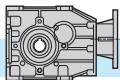

GTF 56B - GTF 63B - GTF 75B

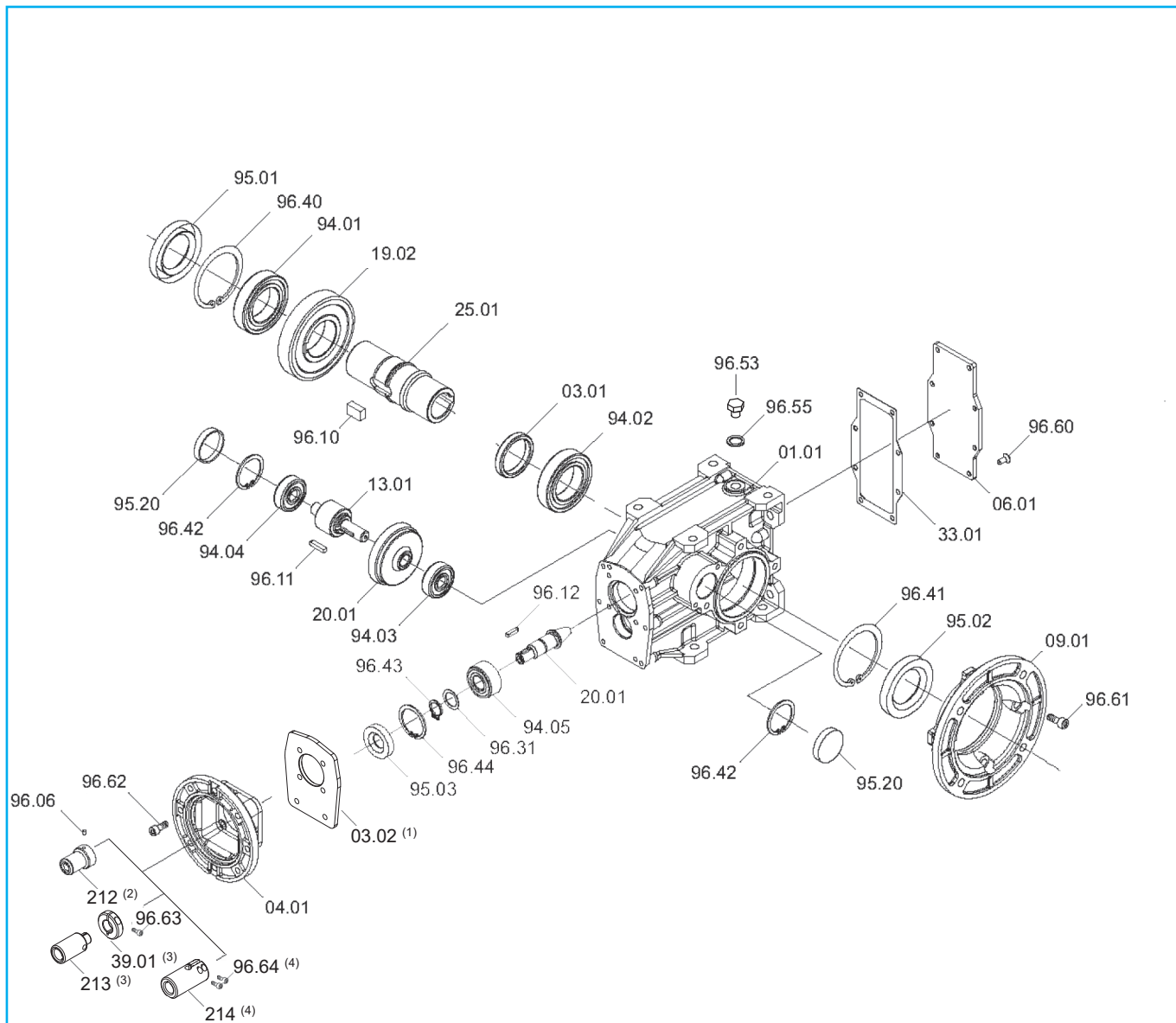

GT	Cuscinetti/ Bearings / Lager					Anelli di tenuta / Oilseals / Öldichtungen			Cappellotto / Closed oil seal / Geschlossene Öldichtung
	94.01	94.02	94.03	94.04	94.05	95.01	95.02	95.03	95.20
56B	6007 35/62/14	6007 35/62/14	6201 12/32/10	6201 12/32/10	3201 12/32/15.9	35/62/7	35/62/7	12/32/7	ø 32x7
63B	6008 40/68/15	6008 40/68/15	6301 12/37/12	6301 12/37/12	3202 15/35/15.9	40/68/10	40/68/10	15/35/7	ø 37x7
75B	6010 50/80/16	6010 50/80/16	6203 17/40/12	6203 17/40/12	3202 15/35/15.9	50/80/8	50/80/8	15/35/7	ø 47x7

(1) Solo per GTF75B PAM 71, 80, 90 / Only for GTF75B PAM 71, 80, 90 / Nur für GT75B PAM 71, 80, 90.

(2) Solo per GTF56B e GTF63B PAM 56, 63 / Only for GTF56B and GTF63B PAM 56, 63 / Nur für GTF56B und GTF63B PAM 56, 63.

(3) Solo per GTF56B e GTF63B PAM 71, 80, 90 / Only for GTF56B and GTF63B PAM 71, 80, 90 / Nur für GTF56B und GTF63B PAM 71, 80, 90.

(4) Solo per GTF75B tutti i PAM / Only for GTF75B all PAM / Nur für GTF75B alle PAM.

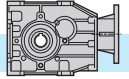

GTF 56C - GTF 63C - GTF 75C

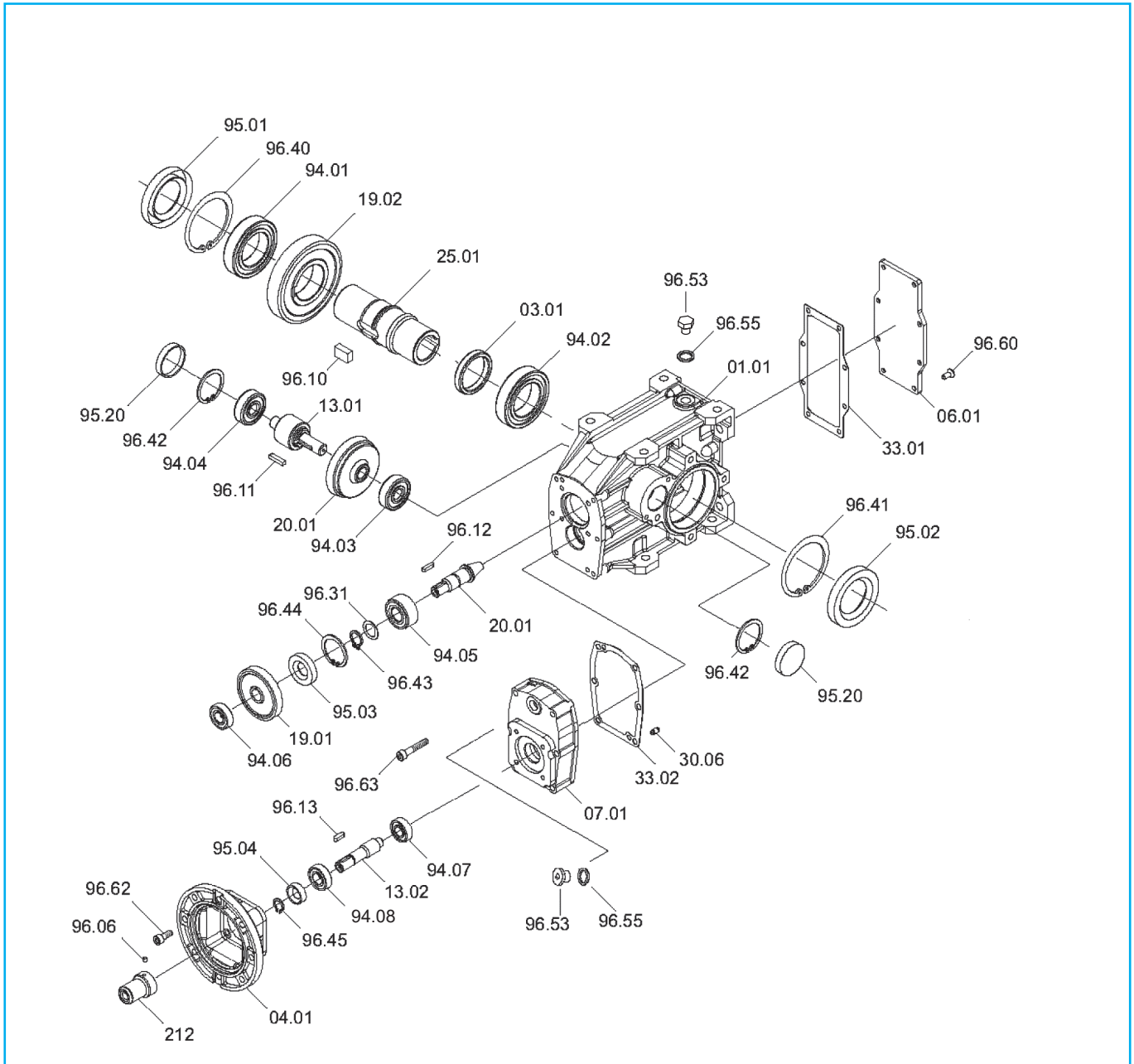

GT	Cuscinetti/ Bearings / Lager								Anelli di tenuta / Oilseals / Öldichtungen				Cappello / Closed oil seal / Geschlossene Öldichtung
	94.01	94.02	94.03	94.04	94.05	94.06	94.07	94.08	95.01	95.02	95.03	95.04	95.20
56C	6007 35/62/14	6007 35/62/14	6201 12/32/10	6201 12/32/10	3201 12/32/15.9	6001 12/28/8	6000 10/26/8	6001 12/28/8	35/62/7	35/62/7	12/32/7	12/22/7	ø 32x7
63C	6008 40/68/15	6008 40/68/15	6301 12/37/12	6301 12/37/12	3202 15/35/15.9	6001 12/28/8	6000 10/26/8	6001 12/28/8	40/68/10	40/68/10	15/35/7	12/22/7	ø 37x7
75C	6010 50/80/16	6010 50/80/16	6203 17/40/12	6203 17/40/12	3202 15/35/15.9	6002 16/32/9	6000 10/26/8	6001 12/28/8	50/80/8	50/80/8	15/35/7	12/22/7	ø 47x7

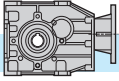

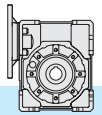

5.0	RIDUTTORI A VITE SENZA FINE GX	GX WORM GEARBOXES	SCHNECKENGETRIEBE GX
5.1	Caratteristiche	<i>Characteristics</i>	Merkmale 78
5.2	Designazione	<i>Designation</i>	Bezeichnung 79
5.3	Rendimento	<i>Efficiency</i>	Wirkungsgrad 80
5.4	Irreversibilità	<i>Irreversibility</i>	Selbsthemmung 80
5.5	Gioco angolare	<i>Backlash</i>	Winkelspiel 81
5.6	Carichi radiali	<i>Radial load</i>	Radialbelastungen 82
5.7	Senso di rotazione	<i>Direction of rotation</i>	Drehrichtung 82
5.8	Lubrificazione e posizioni di montaggio	<i>Lubrication and mounting position</i>	Schmierung und Einbaulage 83
5.9	Posizione morsettiera	<i>Terminal board position</i>	Lage des Klemmbrett 83
5.10	Dati tecnici	<i>Technical data</i>	Technische Daten 84
5.11	Momenti d'inerzia	<i>Moment of inertia</i>	Trägheitsmoment 90
5.12	Dimensioni	<i>Dimensions</i>	Abmessungen 91
5.13	Entrata supplementare	<i>Additional input</i>	Zusatzantrieb 94
5.14	Accessori	<i>Accessories</i>	Zubehör 94
5.15	Lista parti di ricambio	<i>Spare parts list</i>	Ersatzteilliste 95

GHA - MODULAR

La serie MODULAR costituisce la serie basic all'interno della gamma di riduttori GHA.

Le speciali caratteristiche NANOTECHNOLOGICHE del rivestimento e il design basic della carcassa rendono la serie MODULAR particolarmente idonea per applicazioni in ambienti ALIMENTARE (SECCO) e FARMACEUTICO.

I riduttori della serie GHA MODULAR non sono certificati per l'utilizzo a contatto con gli alimenti.

GHA - MODULAR

The MODULAR series is the basic series within the range of GHA reducers.

The special NANOTECHNOLOGICAL characteristics of the coating and the basic design of the casing make the MODULAR Series particularly suitable for applications in FOOD (dry environment) and PHARMACEUTICAL sectors.

The GHA MODULAR series reducers are not certified for use in contact with food.

GHA - MODULAR

Die Serie MODULAR ist die Basisbaureihe innerhalb der Produktpalette der GHA-behandelten Getriebe.

Die speziellen NANOTECHNOLOGISCHEN Eigenschaften der Beschichtung und das grundlegende Design des Gehäuses prädestinieren die MODULAR-Serie für Anwendungen in der Lebensmittel- (trockene Umgebung) und Pharmaindustrie.

Die Getriebe der Serie GHA MODULAR sind nicht für den Einsatz in Kontakt mit Lebensmitteln zugelassen.

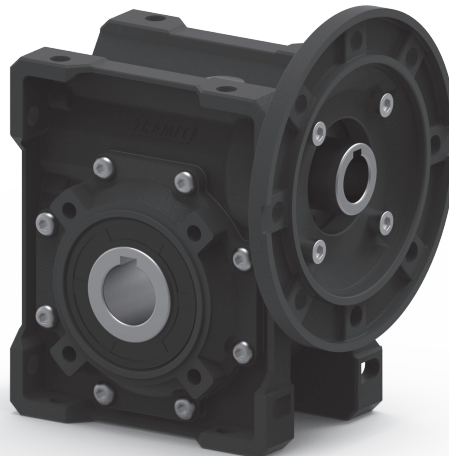

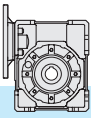

5.1 Caratteristiche

- I riduttori a vite senza fine della serie GX sono disponibili nella versione con predisposizione per attacco motore GXC.
- La serie compatta GXC presenta il vantaggio di un ingombro più ridotto.
- Le carcasse e le flange in lega di alluminio sono sabbiate e trattate con tecnologia G.H.A.
- La vite senza fine è in acciaio legato cementato-temprato ed è rettificata.
- La corona ha il mozzo in acciaio INOX AISI 316 e l'anello dentato in bronzo GCuSn12.
- Viene fornito l'albero uscita cavo di serie in acciaio INOX AISI 316 ed esiste un'ampia disponibilità di accessori: seconda entrata (in acciaio non INOX), flangia uscita e braccio di reazione (in lega di alluminio con trattamento G.H.A. e montato con viti in acciaio inox.)

5.1 Characteristics

- *GX series worm gearboxes are available in the following versions: GXC suitable for motor mounting assembling.*
- *the GX compact version, which actually offers reduced space requirement.*
- *The casings and flanges made of aluminium alloy are sandblasted and treated with G.H.A technology.*
- *The worm shaft is made of hardened-bonded steel and ground.*
- *The wheel has an AISI 316 stainless steel hub with a toothed ring made in bronze GcuSn12.*
- *The hollow output shaft is supplied as standard in AISI 316 stainless steel and there is a wide range of accessories available: second inlet (not in stainless steel), outlet flange and reaction arm (in aluminium alloy with G.H.A treatment and mounted with stainless steel screws).*

5.1 Merkmale

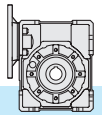

- Die Schneckengetriebe der Serie GX sind in die Version GXC mit Motoranschluß lieferbar.
- Die kompakte GXC-Serie hat den Vorteil einer geringeren Stellfläche
- Die Gehäuse und die Flansche aus Aluminiumlegierung sind sandgestrahlt und mit G.H.A.-Technologie hergestellt.
- Die Schneckenwelle ist aus einsatzgehärtetem, abgeschrecktem und daraufhin geschliffenem Legierungsstahl
- Das Schneckenrad besteht aus einer Nabe aus Edelstahl AISI 316 und einer Bronze- Verzahnung GCuSn12.
- Die hohle Abtriebswelle wird standardmäßig aus Edelstahl AISI 316 geliefert und es gibt eine große Auswahl an Zubehör: zweiter Eingang (nicht aus Edelstahl), Abtriebsflansch und Reaktionsarm (aus Aluminiumlegierung mit G.H.A.-Behandlung und mit Edelstahlschrauben montiert).



5.2 Designazione

5.2 Designation

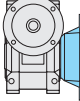
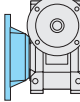
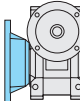
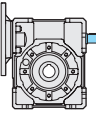
5.2 Bezeichnung

Riduttore Gearbox Getriebe	Tipo entrata Input type Antriebsart	Grandezza Size Größe	Rapporto rid. Ratio Untersetzung	Predispos.att. mot. Motor coupling Motoranschluss	Posizione di mont. Mounting position Einbaulage	Albero uscita Output shaft Abtriebswelle	Flangia in uscita. Output flange Abtriebsflansch	Seconda entrata Additional input Zusatzantrieb	Braccio di reazione Torque arm Drehmomentstütze	Campo di applicazione Field of application Anwendungsbereich
GX	C	50	10/1	P.A.M	B3	H25	F1S	SeA	BR	A
Riduttore a vite senza fine Wormgearbox Schneckengetriebe		30 40 50 63 75 89	5 7.5 10 15 20 25 30 40 50 65 80 100	56 63 71 80 90 100 112	B3, B6 B7, B8 V5, V6	H..	 F1D-F2D-F3D  F1S-F2S-F3S  F12-F22-F32	 SeA	 BR	A Alimentare e Farmaceutico Food and Pharmaceutical Lebensmittel- und Pharmaindustrie M* Marino Marine Schifffahrt

*: a richiesta

*: on request

*: auf Anfrage

Tipo entrata

Input type

Antriebstyp

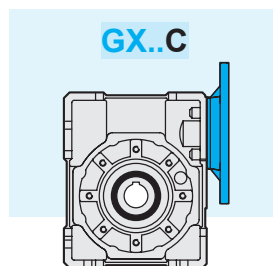

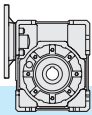

5.3 Rendimento

Rd - È il rendimento dinamico, definito come rapporto tra la potenza in uscita P_2 e quella in entrata P_1 . Dipende principalmente dalla velocità di strisciamento, dal tipo di lubrificante e dall'angolo d'elica. I valori indicati nelle tabelle sono validi se si applica la corrispondente coppia in uscita. In fase di rodaggio, circa le prime 300 ore di funzionamento sotto carico, il valore deve essere considerato inferiore del 30% rispetto a quello indicato in tabella.

Rs - È il rendimento statico che si ha al momento dell'avviamento del riduttore e varia in base al rapporto di riduzione. Risulta importante, per una corretta valutazione del riduttore da impiegare, nelle applicazioni in cui non si raggiungono mai le condizioni di regime come nei funzionamenti intermittenti. Analogamente al caso dinamico, anche il rendimento statico durante il rodaggio risulta inferiore del 30% rispetto al valore indicato in tabella.

5.3 Efficiency

Rd - dynamic efficiency, defined as the ratio between P_2 output power and P_1 input power. It mainly depends on the slipping speed, the type of lubricant and the lead angle. The values reported in the table are valid when the corresponding output torque is applied. During the first 300 operating hours under load, the value to be considered is 30% lower than that reported in the table.

Rs - static efficiency at gearbox start-up; it changes depending on the reduction ratio. Rs value is important for selecting the right gearbox for applications where a steady state is never achieved, as for intermittent duty applications. Same as dynamic efficiency, static efficiency too during the running-in period will be 30% lower than the value reported in the table.

5.3 Wirkungsgrad

Rd - dynamischer Wirkungsgrad, ist das Verhältnis zwischen P_2 Abtriebsleistung und P_1 Antriebsleistung. Rd Wert wird durch Gleitgeschwindigkeit, Art des Schmiermittels und Steigungswinkel beeinflusst. Die Tabellen zeigen die Werte die gültig sind wenn das entsprechende Abtriebsdrehmoment gegeben ist. Während der Einlaufzeit in den ersten 300 Betriebsstunden unter Belastung, ist dieser Wert 30% niedriger als der in der Leistungstabelle angegebenen Wert.

Rs - statischer Wirkungsgrad beim Getriebebestart und in Abhängigkeit zur Unterersetzung. Der Wert Rs ist wichtig für die Auswahl des richtigen Getriebes für Anwendungen wo ein stetiger Betrieb nicht auftritt, wie bei Anwendungen mit Aussetzbetrieb. Der statischer Wirkungsgrad auch während der Einlaufzeit wird 30% niedriger als der in der Tabelle angegebenen Wert.

GX	Rs											
	5	7.5	10	15	20	25	30	40	50	65	80	100
30	0.70	0.67	0.62	0.55	0.47	0.43	0.39	0.30	0.27	0.25	0.22	0.21
40	0.69	0.67	0.63	0.55	0.52	0.45	0.40	0.35	0.29	0.26	0.25	0.23
50	0.69	0.68	0.65	0.58	0.53	0.47	0.41	0.37	0.32	0.28	0.25	0.23
63	0.70	0.68	0.65	0.57	0.55	0.50	0.47	0.38	0.33	0.29	0.28	0.23
75	/	0.68	0.65	0.58	0.55	0.51	0.43	0.39	0.35	0.31	0.28	0.24
89	/	0.68	0.65	0.58	0.55	0.52	0.45	0.39	0.36	0.32	0.29	0.25

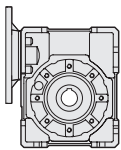

5.4 Irreversibilità

Nelle applicazioni dove è necessario evitare la trasmissione del moto retrogrado o sostenere il carico, in assenza di alimentazione elettrica, è consigliabile adottare freni esterni.

Nei riduttori a vite senza fine emerge questa caratteristica naturale, denominata grado di irreversibilità, che cresce con l'aumentare del rapporto di riduzione in quanto strettamente legata al relativo rendimento.

Per ottenere alti gradi di irreversibilità occorre quindi adottare i rapporti di riduzione più elevati, senza dimenticare che, il rendimento, tende a crescere durante le prime 500 ore di funzionamento per poi stabilizzarsi sui valori riportati a catalogo.

5.4 Irreversibility

The use of external brakes is advised in case of applications where backwards motion must be hindered and the load must be held should the feed be cut off.

Some worm gearboxes feature natural irreversibility. The higher the ratio, the higher is the irreversibility, since it is strictly dependent on the relative efficiency.

In order to achieve high irreversibility it is therefore necessary to select higher efficiency reduction ratios not to forget that the efficiency is growing during the first 500 hours life until it stabilizes to the values mentioned in the catalogue.

5.4 Selbsthemmung

Aussenbremsen sind bei Anwendungen zu benutzen, bei denen Rückbewegung vermeiden werden muss oder die Last auch im Falle von Fehlen an Speisung gehalten werden muss.

Einige Schneckengetriebe sind selbsthemmend. Je höher die Unterersetzung ist, desto höher ist die Selbsthemmung, da diese stark vom jeweiligen Wirkungsgrad abhängig ist. Um eine höhere Selbsthemmung zu erreichen, wählen Sie bitte höhere Untersetzungsverhältnisse.

Bitte beachten Sie, dass der Wirkungsgrad der Getriebe in den ersten 500 Betriebsstunden ansteigt und sich erst anschließend auf die im Katalog angegebenen Werte stabilisiert.

Irreversibilità statica

Condizione di impedimento alla rotazione comandata dall'albero lento senza escludere possibili ritorni lenti nel caso in cui il carico sia sottoposto a vibrazioni.

Rs < 0.45 si ha irreversibilità
Rs = 0.45 ÷ 0.55 irreversibilità incerta
Rs > 0.55 si ha reversibilità

Static irreversibility

Static irreversibility occurs when the rotation controlled by the output shaft is hindered; possible slow returns cannot be excluded should the load be subject to vibrations.

Rs < 0.45 provides irreversibility
Rs = 0.45 ÷ 0.55 irreversibility is uncertain
Rs > 0.55 reversibility is possible

Statische Selbsthemmung

Statische Selbsthemmung liegt vor, wenn die von Abtriebswelle gesteuerten Drehung gehindert wird. Langsamer Rücklauf ist möglich, falls die Last Schwingungen ausgesetzt wird.

Rs < 0.45 es liegt Selbsthemmung vor
Rs = 0.45 ÷ 0.55 ungewisse Selbsthemmung
Rs > 0.55 es liegt Reversibilität vor

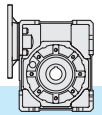

Irreversibilità dinamica

Condizione di arresto e quindi di sostegno del carico nel momento in cui cessa l'azione di comando. La condizione è più difficile da ottenere in quanto viene influenzata dal rendimento dinamico, dalla velocità di rotazione, da eventuali vibrazioni che il carico può generare e dalla direzione del movimento rispetto al carico.

Quest'ultima condizione è molto evidente nei sollevamenti: un carico in salita, cessando l'azione di comando, deve arrestarsi e quindi assumere velocità zero (rendimento statico) prima di invertire il moto e cadere per gravità.

Un carico in discesa tende invece a proseguire nel suo moto ostacolato, nella caduta, dal solo rendimento dinamico.

Rd < 0.45 si ha irreversibilità
Rd = 0.45 ÷ 0.55 irreversibilità incerta
Rd > 0.55 si ha reversibilità

Dynamic irreversibility

Dynamic irreversibility is characterized by stillstand and hold of the load when the drive stops. It is more difficult to achieve this condition because it is influenced by dynamic efficiency, speed of rotation and possible vibrations generated by the motion direction with regard to the load.

This last condition is much more evident during the lifting: if the drive stops during the lifting of the load this has to come to a speed equals to zero (static irreversibility) before the reversal of motion rotation and its drop for gravity.

On the contrary the load during its descent gets its motion obstructed by its dynamic efficiency.

Rd < 0.45 provides irreversibility
Rd = 0.45 ÷ 0.55 irreversibility is uncertain
Rd > 0.55 reversibility is possible

Dynamische Selbsthemmung

Stillstand und Stütze der Last beim Aussetzen der Steuerung. Diese Bedingung ist schwieriger zu erreichen, da sie vom dynamischen Wirkungsgrad, der Drehzahl und von der Last verursachten möglichen Vibrationen abhängig ist

Dieser letzte Fall kommt bei Hubanwendungen stark zu tragen. Wenn der Antrieb während dem Hub stoppt, muss die Last eine Geschwindigkeit von annähernd null erreichen (statische Irreversibilität), bevor die Rotation sich umkehrt und die Last durch die Gravitation nach unten fährt.

Dem entgegengesetzt bekommt die Last durch die Abwärtsbewegung Ihre dynamische Effizienz.

Rd < 0.45 es liegt Selbsthemmung vor
Rd = 0.45 ÷ 0.55 ungewisse Selbsthemmung
Rd > 0.55 es liegt Reversibilität vor

5.5 Gioco angolare

Gioco angolare standard

Misurato bloccando l'albero entrata, e ruotando l'albero uscita nelle due direzioni applicando la coppia strettamente necessaria a creare il contatto tra i denti degli ingranaggi, al massimo pari al 2% della coppia nominale (T_{2M}).

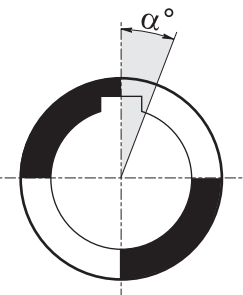

5.5 Backlash

Backlash

Angular backlash measured after having blocked the input shaft by rotating output shaft in both directions and applying the torque which is strictly necessary to create a contact between the teeth of the gears. The applied torque should be at most 2% of the max. torque (T_{2M}).

5.5 Winkelspiel

Winkelspiel

Nachdem die Antriebswelle blockiert worden ist, darf das Winkelspiel auf die Abtriebswelle bemessen werden. Dabei soll die Antriebswelle in beiden Richtungen gedreht werden und ein Drehmoment ausgeübt werden, das zur Entstehen eines Kontaktes zwischen den Zähnen genuegt. Das ausgeübte Drehmoment soll höchstens 2% des max. von Getrieben garantierten Drehmoment (T_{2M}) sein.

GX						
i_n	30	40	50	63	75	89
	max	max	max	max	max	max
5	16'	13.5'	10.5'	10'	/	/
7.5	16'	13.5'	10.5'	10'	10'	9.5'
10	16'	13.5'	10.5'	10'	10'	9'
15	16'	13.5'	10.5'	10'	10'	9'
20	14.5'	12'	9.5'	8.5'	8.5'	8.5'
25	14.5'	12'	9.5'	8.5'	8.5'	8.5'
30	14.5'	12'	8.5'	8.5'	8.5'	8.5'
40	14.5'	12'	9.5'	8.5'	8.5'	8'
50	14'	12'	9.5'	8.5'	8.5'	8'
65	14'	12'	9'	8'	8'	8'
80	13.5'	11.5'	9'	7.5'	7.5'	7.5'
100	13'	11'	9'	7.5'	7.5'	7.5'

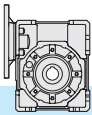

5.6 Carichi radiali

Carichi radiali Fr_2 e assiali Fa_2 sull'albero uscita [N]

Se il carico radiale sull'albero non è applicato a metà della sporgenza dell'albero, il valore del carico ammissibile deve essere valutato utilizzando la formula che si riferisce ad Fry_2 , in cui i valori di a, b e Fr_2 sono riportati nelle tabelle relative ai carichi radiali.

Nel caso di alberi bisporgenti il valore del carico applicabile a ciascuna estremità è uguale ai 2/3 del valore di tabella, purchè i carichi applicati siano uguali di intensità e direzione ed agiscano nello stesso senso. Diversamente contattare il servizio tecnico.

5.6 Radial load

Fr_2 radial loads and Fa_2 axial loads on the output shaft [N]

Should the radial load affect the shaft not at the half-way point of its projection but at a different point, the value of the admissible load has to be calculated using the Fry_2 formula: a, b and Fr_2 values are reported in the radial load tables.

With regard to double-projecting shafts, the load applicable at each end is 2/3 of the value given in the table, on condition that the applied loads feature same intensity and direction and that they act in the same direction.

Otherwise please contact the technical department.

5.6 Radialbelastungen

Fr_2 Radialbelastungen und Fa_2 Axialbelastungen auf die Abtriebswelle [N]

Falls die Radialbelastungen nicht in dem Mittelpunkt der herausragenden Welle sondern in einem anderen Punkt wirken, soll die zulässige Belastung mit der Formel bezüglich Fry_2 kalkuliert werden: a, b und Fr_2 Werte sind aus der Tabelle der Radialbelastungen zu entnehmen.

Bei doppelseitigen Abtriebswellen ist die Belastung, die an jedem Ende anwendbar ist, 2/3 des in der Tabelle angegebenen Wertes unter der Bedingung, dass die Belastungen die selbe Stärke und Richtung aufweisen und dass sie in der selben Richtung wirken. Andernfalls muß mit dem technischen Büro Rücksprache gehalten werden.

I carichi radiali indicati nelle tabelle si intendono applicati a metà della sporgenza dell'albero e sono riferiti ai riduttori operanti con fattore di servizio 1.

The radial loads indicated in the chart are considered to be applied at the half-way point of the shaft projection, and refer to gear units operating with service factor 1.

Die Radialbelastungen, die in den Tabellen angegeben werden, gelten für Ansatzpunkte in der Mitte des herausragenden Wellenteils und für Getriebe mit Betriebsfaktor 1.

		GX											
$n_1=1400$ rpm		30		40		50		63		75		89	
i_n	n_2 [rpm]	a = 66.5 b = 49		a = 83.5 b = 60.5		a = 102 b = 73.5		a = 122.5 b = 93.5		a = 134 b = 100		a = 163 b = 118	
		Fr_2	Fa_2	Fr_2	Fa_2	Fr_2	Fa_2	Fr_2	Fa_2	Fr_2	Fa_2	Fr_2	Fa_2
5	280	700	140	1400	280	1400	300	1800	360	/	/	/	/
7.5	187	750	150	1500	300	1650	330	2100	420	2500	500	2600	520
10	140	800	160	1600	320	1800	360	2300	460	2800	560	3000	600
15	93	850	170	1700	340	1950	390	2600	520	3000	600	3400	680
20	70	900	180	1800	360	2200	440	2800	560	3300	660	3800	760
25	56	950	190	1900	380	2400	480	3100	620	3700	740	4100	820
30	47	1000	200	2000	400	2600	520	3400	680	4000	800	4500	900
40	35	1050	210	2100	420	2850	570	3700	740	4400	880	4900	980
50	28	1100	220	2200	440	3100	620	4000	800	4850	970	5300	1060
60	23	1150	230	2400	480	3200	640	4200	840	5000	1000	5600	1120
63	22	1250	250	2500	500	3400	680	4450	890	5300	1060	5900	1180
80	17.5	1350	270	2700	540	3800	760	4900	980	5800	1160	6500	1300
100	14	1500	300	3000	600	4000	800	5400	1080	6500	1300	7000	1400

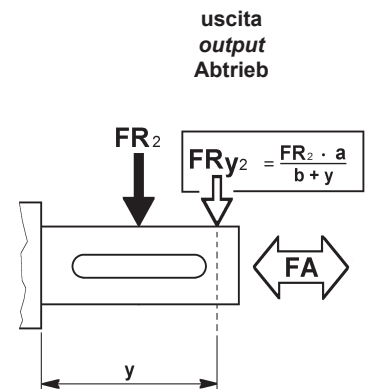

5.7 Senso di rotazione

5.7 Direction of rotation

5.7 Drehrichtung

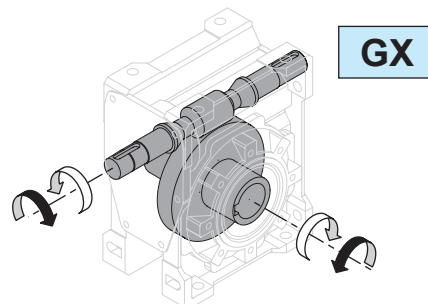

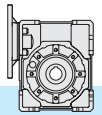

5.8 Lubrificazione

I riduttori a vite senza fine serie GX sono forniti completi di lubrificante sintetico per uso alimentare: OLIO FUCHS CASSIDA FLUID 320.

Si raccomanda di precisare sempre, in fase di ordine, la posizione di montaggio desiderata. Per ulteriori dettagli consultare pag. 17 paragrafo 1.6

Posizioni di montaggio

5.8 Lubrication

The GX series worm gearboxes are supplied complete with synthetic lubricant for food use: FUCHS CASSIDA FLUID 320 OIL.

It is recommended to always specify the desired assembly position when placing the order. For further details, please see page 17 paragraph 1.6

Mounting positions

5.8 Schmierung

Die Schneckengetriebe der Serie GX werden mit synthetischem Lebensmittelöl FUCHS CASSIDA FLUID 320 geliefert.

Es wird empfohlen, bei der Bestellung immer die gewünschte Einbaulage anzugeben. Für weitere Details siehe Seite 17, Absatz 1.6.

Einbaulagen

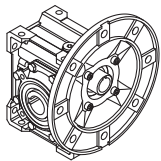

B3

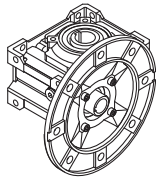

B6

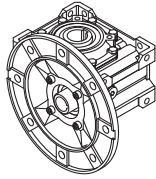

B7

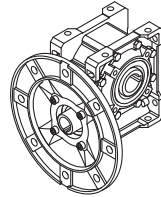

B8

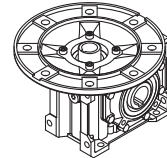

V5

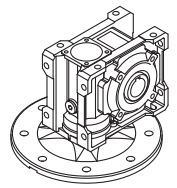

V6

		Q.tà olio / Oil quantity / Schmiermittelmenge [lt]			
		Posizione di montaggio / Mounting position / Einbaulage			
		B3	B6 - B7	B8	V5 - V6
GX	30	0.015	0.030	0.015	
	40	0.040	0.060	0.040	
	50	0.080	0.120	0.080	
	63	0.160	0.220	0.160	
	75	0.260	0.340	0.260	
	89	1.1	0.9	1	1.5

E' presente un solo tappo di riempimento olio.

Aluminium housings have one oil filling plug only.

Aluminiumgehäuse verfügen über 1 Einfüllschraube.

5.9 Posizione morsettiera

5.9 Terminal board position

5.9 Lage der Klemmenkaste

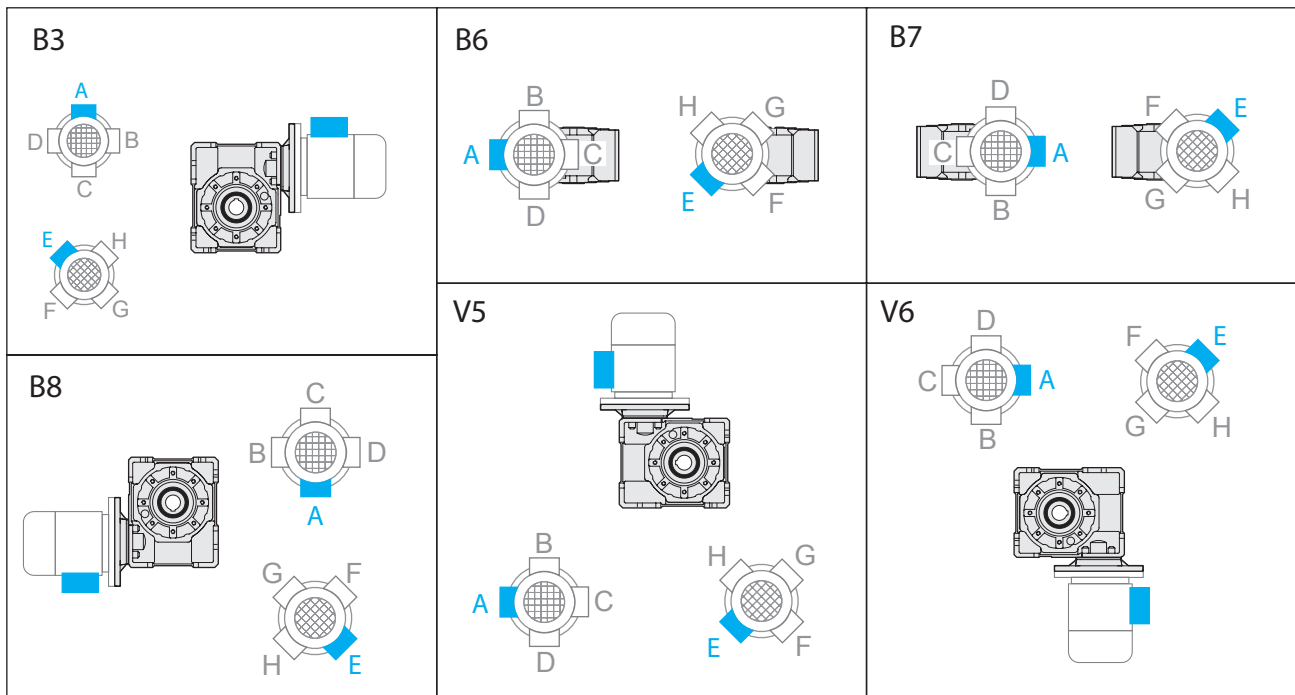

Specificare sempre in fase di ordinazione la posizione di montaggio e la forma costruttiva. Posizione morsettiera v. pag. 89 (PM=1; PM=2)

Mounting position always to be specified when ordering. Terminal board position see page 89 (PM=1; PM=2)

Bei der Bestellung immer die gewünschte Montageposition und Bauform angeben. Lage der Klemmenkaste Seite 89 (PM=1; PM=2)

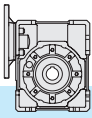

5.10 Dati tecnici

5.10 Technical data

5.10 Technische Daten

GXC 30	$n_1 = 2800$				MOTORI / MOTORS / ENGINE GHA CLASSIC				Input - IEC	
	i_n	n_2 [min ⁻¹]	Rd	P_{t0}	T_2 [Nm]	P_1 [kW]	FS'	B5/B14		
	5	560	0.89	—	5.6	0.37	2.5	63	56	
7.5	373	0.86	8		0.37	2.0				
10	280	0.84	11		0.37	1.5				
15	187	0.81	15		0.37	1.1				
20	140	0.76	13		0.25	1.2				
25	112	0.74	16		0.25	1.0				
30	93	0.71	13		0.18	1.0				
40	70	0.65	16		0.18	1.0				
50	56	0.62	14		0.13	1.1				
65	43	0.57	17		0.13	1.0				
80	35	0.54	13		0.09	1.0				
100	28	0.52	16	0.09	0.8	—	—			



1.4

GXC 30	$n_1 = 1400$				MOTORI / MOTORS / ENGINE GHA CLASSIC				Input - IEC	
	i_n	n_2 [min ⁻¹]	Rd	P_{t0}	T_2 [Nm]	P_1 [kW]	FS'	B5/B14		
	5	280	0.87	0.40	6.5	0.22	2.9	63	56	
7.5	187	0.84	0.40	9	0.22	2.2				
10	140	0.82	0.40	12	0.22	1.8				
15	93	0.77	0.30	17	0.22	1.3				
20	70	0.72	0.20	18	0.18	1.1				
25	56	0.69	0.20	21	0.18	1.0				
30	47	0.66	0.20	18	0.13	1.1				
40	35	0.59	0.20	21	0.13	1.0				
50	28	0.55	0.20	17	0.09	1.1				
65	22	0.51	0.10	20	0.09	1.0				
80	18	0.48	0.10	16	0.06	1.0				
100	14	0.45	0.10	18	0.06	0.8	—	—		



1.4

GXC 30	$n_1 = 900$				MOTORI / MOTORS / ENGINE GHA CLASSIC				Input - IEC	
	i_n	n_2 [min ⁻¹]	Rd	P_{t0}	T_2 [Nm]	P_1 [kW]	FS'	B5/B14		
	5	180	0.85	—	5.9	0.13	3.9	63	56	
7.5	120	0.82	9		0.13	2.9				
10	90	0.80	11		0.13	2.3				
15	60	0.75	15		0.13	1.6				
20	45	0.69	19		0.13	1.2				
25	36	0.66	23		0.13	1.1				
30	30	0.63	18		0.09	1.2				
40	23	0.55	21		0.09	1.1				
50	18	0.52	16		0.06	1.1				
65	14	0.48	20		0.06	1.1				
80	11	0.44	11		0.03	1.7				
100	9	0.42	13	0.03	1.1	—	—			



1.4

GXC 30	$n_1 = 500$				MOTORI / MOTORS / ENGINE GHA CLASSIC				Input - IEC	
	i_n	n_2 [min ⁻¹]	Rd	P_{t0}	T_2 [Nm]	P_1 [kW]	FS'	B5/B14		
	5	100	0.83	—	—	—	—	63	56	
7.5	67	0.80	—		—	—				
10	50	0.77	—		—	—				
15	33	0.72	—		—	—				
20	25	0.66	—		—	—				
25	20	0.62	—		—	—				
30	17	0.59	—		—	—				
40	13	0.51	—		—	—				
50	10	0.48	—		—	—				
65	8	0.43	—		—	—				
80	6	0.40	—		—	—				
100	5	0.38	—	—	—	—	—			



1.4

* **ATTENZIONE:** la coppia massima utilizzabile $[T_{2M}]$ deve essere calcolata utilizzando il fattore di servizio: $T_{2M} = T_2 \times FS'$

* **WARNING:** Maximum allowable torque $[T_{2M}]$ must be calculated using the following service factor: $T_{2M} = T_2 \times FS'$

* **ACHTUNG:** das max. anwendbare Drehmoment $[T_{2M}]$ muss mit folgendem Betriebsfaktor berechnet werden: $T_{2M} = T_2 \times FS'$

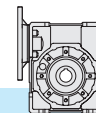

5.10 Dati tecnici

5.10 Technical data

5.10 Technische Daten

GXC 40	n₁ = 2800				MOTORI / MOTORS / ENGINE GHA CLASSIC						
	i _n	n ₂ [min ⁻¹]	Rd	P ₁₀	T ₂ [Nm]	P ₁ [kW]	FS'	Input - IEC			
								B5/B14			
Kg 2.4	5	560	0.88	—	11.3	0.75	2.2	71	63	—	
	7.5	373	0.87		17	0.75	1.8				
	10	280	0.86		22	0.75	1.4				
	15	187	0.82		32	0.75	1.0				
	20	140	0.80		30	0.55	1.0				
	25	112	0.76		24	0.37	1.1				
	30	93	0.73		28	0.37	1.3				
	40	70	0.70		24	0.25	1.4				
	50	56	0.65		28	0.25	1.1				
	65	43	0.61		24	0.18	1.2				
	80	35	0.58		21	0.13	1.3				
	100	28	0.55		24	0.13	1.0				

GXC 40	n₁ = 1400				MOTORI / MOTORS / ENGINE GHA CLASSIC						
	i _n	n ₂ [min ⁻¹]	Rd	P ₁₀	T ₂ [Nm]	P ₁ [kW]	FS'	Input - IEC			
								B5/B14			
Kg 2.4	5	280	0.87	0.80	16.3	0.55	2.1	71	63	—	
	7.5	187	0.85	0.80	24	0.55	1.7				
	10	140	0.83	0.70	31	0.55	1.3				
	15	93	0.79	0.50	30	0.37	1.4				
	20	70	0.76	0.50	38	0.37	1.0				
	25	56	0.72	0.40	31	0.25	1.1				
	30	47	0.68	0.40	35	0.25	1.2				
	40	35	0.64	0.30	38	0.22	1.0				
	50	28	0.59	0.30	36	0.18	1.1				
	65	22	0.54	0.20	31	0.13	1.1				
	80	18	0.52	0.20	31	0.11	1.1				
	100	14	0.49	0.20	30	0.09	0.9				

GXC 40	n₁ = 900				MOTORI / MOTORS / ENGINE GHA CLASSIC						
	i _n	n ₂ [min ⁻¹]	Rd	P ₁₀	T ₂ [Nm]	P ₁ [kW]	FS'	Input - IEC			
								B5/B14			
Kg 2.4	5	180	0.85	—	16.7	0.37	2.5	71	63	—	
	7.5	120	0.83		25	0.37	2.0				
	10	90	0.81		32	0.37	1.5				
	15	60	0.76		45	0.37	1.1				
	20	45	0.74		39	0.25	1.2				
	25	36	0.69		33	0.18	1.3				
	30	30	0.65		37	0.18	1.3				
	40	23	0.61		33	0.13	1.3				
	50	18	0.55		38	0.13	1.1				
	65	14	0.51		32	0.09	1.2				
	80	11	0.48		37	0.09	1.0				
	100	9	0.45		29	0.06	1.0				

GXC 40	n₁ = 500				MOTORI / MOTORS / ENGINE GHA CLASSIC						
	i _n	n ₂ [min ⁻¹]	Rd	P ₁₀	T ₂ [Nm]	P ₁ [kW]	FS'	Input - IEC			
								B5/B14			
Kg 2.4	5	100	0.83	—	7.1	0.09	7.1	71	63	—	
	7.5	67	0.81		10	0.09	5.5				
	10	50	0.79		14	0.09	4.4				
	15	33	0.73		19	0.09	3.1				
	20	25	0.70		24	0.09	2.3				
	25	20	0.65		28	0.09	1.7				
	30	17	0.61		31	0.09	1.8				
	40	13	0.57		39	0.09	1.3				
	50	10	0.51		44	0.09	1.2				
	65	8	0.46		52	0.09	0.9				
	80	6	0.44		61*	0.09	0.7*				
	100	5	0.41		71*	0.09	0.4*				

* **ATTENZIONE:** la coppia massima utilizzabile [T_{2M}] deve essere calcolata utilizzando il fattore di servizio: T_{2M} = T₂ x FS'

* **WARNING:** Maximum allowable torque [T_{2M}] must be calculated using the following service factor: T_{2M} = T₂ x FS'

* **ACHTUNG:** das max. anwendbare Drehmoment [T_{2M}] muss mit folgendem Betriebsfaktor berechnet werden: T_{2M} = T₂ x FS'

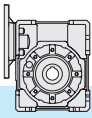

5.10 Dati tecnici

5.10 Technical data

5.10 Technische Daten

GXC 50	n₁ = 2800				MOTORI / MOTORS / ENGINE GHA CLASSIC						
	i _n	n ₂ [min ⁻¹]	Rd	P ₁₀	T ₂ [Nm]	P ₁ [kW]	FS'	Input - IEC			
								B5/B14			
 4.0	5	560	0.89	—	22.8	1.5	1.9	80	71	—	
	7.5	373	0.88		34	1.5	1.5				
	10	280	0.86		44	1.5	1.2				
	15	187	0.84		47	1.1	1.2				
	20	140	0.81		42	0.75	1.4				
	25	112	0.78		50	0.75	1.0				
	30	93	0.75		42	0.55	1.3				
	40	70	0.72		54	0.55	1.0				
	50	56	0.68		43	0.37	1.3				
	65	43	0.64		53	0.37	1.0				
80	35	0.61	41	0.25	1.2	—		63			
100	28	0.58	35	0.18	1.3						

GXC 50	n₁ = 1400				MOTORI / MOTORS / ENGINE GHA CLASSIC						
	i _n	n ₂ [min ⁻¹]	Rd	P ₁₀	T ₂ [Nm]	P ₁ [kW]	FS'	Input - IEC			
								B5/B14			
 4.0	5	280	0.87	1.2	26.7	0.9	2.3	80	71	—	
	7.5	187	0.86	1.2	40	0.9	1.8				
	10	140	0.84	1.0	52	0.9	1.4				
	15	93	0.80	0.80	74	0.9	1.0				
	20	70	0.78	0.70	58	0.55	1.3				
	25	56	0.74	0.60	47	0.37	1.4				
	30	47	0.71	0.60	53	0.37	1.2				
	40	35	0.67	0.50	68	0.37	1.0				
	50	28	0.62	0.40	53	0.25	1.3				
	65	22	0.58	0.40	64	0.25	1.0				
80	18	0.54	0.40	53	0.18	1.1	—		63		
100	14	0.51	0.30	45	0.13	1.2					

GXC 50	n₁ = 900				MOTORI / MOTORS / ENGINE GHA CLASSIC						
	i _n	n ₂ [min ⁻¹]	Rd	P ₁₀	T ₂ [Nm]	P ₁ [kW]	FS'	Input - IEC			
								B5/B14			
 4.0	5	180	0.85	—	33.8	0.75	2.2	80	71	—	
	7.5	120	0.84		50	0.75	1.6				
	10	90	0.82		66	0.75	1.3				
	15	60	0.78		68	0.55	1.3				
	20	45	0.75		59	0.37	1.5				
	25	36	0.71		70	0.37	1.1				
	30	30	0.67		79	0.37	1.0				
	40	23	0.63		67	0.25	1.1				
	50	18	0.59		78	0.25	1.0				
	65	14	0.54		67	0.18	1.1				
80	11	0.51	56	0.13	1.2	—		63			
100	9	0.47	45	0.09	1.3						

GXC 50	n₁ = 500				MOTORI / MOTORS / ENGINE GHA CLASSIC						
	i _n	n ₂ [min ⁻¹]	Rd	P ₁₀	T ₂ [Nm]	P ₁ [kW]	FS'	Input - IEC			
								B5/B14			
 4.0	5	100	0.84	—	14.3	0.18	6.4	80	71	—	
	7.5	67	0.82		21	0.18	4.7				
	10	50	0.80		28	0.18	3.8				
	15	33	0.75		39	0.18	2.7				
	20	25	0.72		50	0.18	2.1				
	25	20	0.68		58	0.18	1.5				
	30	17	0.63		65	0.18	1.5				
	40	13	0.59		81	0.18	1.2				
	50	10	0.54		93	0.18	1.0				
	65	8	0.50		56	0.09	1.5				
80	6	0.46	63	0.09	1.2	—		63			
100	5	0.43	74	0.09	0.8						

* **ATTENZIONE:** la coppia massima utilizzabile [T_{2M}] deve essere calcolata utilizzando il fattore di servizio: T_{2M} = T₂ x FS'

* **WARNING:** Maximum allowable torque [T_{2M}] must be calculated using the following service factor: T_{2M} = T₂ x FS'

* **ACHTUNG:** das max. anwendbare Drehmoment [T_{2M}] muss mit folgendem Betriebsfaktor berechnet werden: T_{2M} = T₂ x FS'

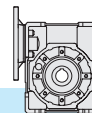

5.10 Dati tecnici

5.10 Technical data

5.10 Technische Daten

GXC 63	n₁ = 2800				MOTORI / MOTORS / ENGINE GHA CLASSIC						
	i _n	n ₂ [min ⁻¹]	Rd	P ₁₀	T ₂ [Nm]	P ₁ [kW]	FS'	Input - IEC			
								B5/B14			
Kg 6.6	5	560	0.89	—	45.5	3	1.7	90	80	—	
	7.5	373	0.88		68	3	1.3				
	10	280	0.87		89	3	1.1				
	15	187	0.84		95	2.2	1.0				
	20	140	0.83		85	1.5	1.3				
	25	112	0.81		76	1.1	1.2				
	30	93	0.77		87	1.1	1.3				
	40	70	0.74		111	1.1	1.1	—	71		
	50	56	0.70		90	0.75	1.1				
	65	43	0.67		81	0.55	1.2				
	80	35	0.64		65	0.37	1.4				
	100	28	0.60		75	0.37	1.1				

GXC 63	n₁ = 1400				MOTORI / MOTORS / ENGINE GHA CLASSIC						
	i _n	n ₂ [min ⁻¹]	Rd	P ₁₀	T ₂ [Nm]	P ₁ [kW]	FS'	Input - IEC			
								B5/B14			
Kg 6.6	5	280	0.88	1.8	54	1.8	2.0	90	80	—	
	7.5	187	0.87	1.8	80	1.8	1.5				
	10	140	0.85	1.6	105	1.8	1.2				
	15	93	0.81	1.2	125	1.5	1.1				
	20	70	0.80	1.2	120	1.1	1.2				
	25	56	0.77	1.0	118	0.9	1.0				
	30	47	0.73	0.90	134	0.9	1.1	—	71		
	40	35	0.69	0.80	142	0.75	1.1				
	50	28	0.65	0.70	122	0.55	1.0				
	65	22	0.61	0.60	100	0.37	1.2				
	80	18	0.58	0.60	79	0.25	1.4				
	100	14	0.53	0.50	91	0.25	1.1				

GXC 63	n₁ = 900				MOTORI / MOTORS / ENGINE GHA CLASSIC						
	i _n	n ₂ [min ⁻¹]	Rd	P ₁₀	T ₂ [Nm]	P ₁ [kW]	FS'	Input - IEC			
								B5/B14			
Kg 6.6	5	180	0.87	—	69	1.5	1.9	90	80	—	
	7.5	120	0.85		102	1.5	1.4				
	10	90	0.83		133	1.5	1.1				
	15	60	0.79		139	1.1	1.1				
	20	45	0.77		123	0.75	1.4				
	25	36	0.74		109	0.55	1.3				
	30	30	0.70		122	0.55	1.3				
	40	23	0.66		154	0.55	1.1	—	71		
	50	18	0.61		120	0.37	1.2				
	65	14	0.57		98	0.25	1.4				
	80	11	0.54		115	0.25	1.1				
	100	9	0.50		95	0.18	1.2				

GXC 63	n₁ = 500				MOTORI / MOTORS / ENGINE GHA CLASSIC						
	i _n	n ₂ [min ⁻¹]	Rd	P ₁₀	T ₂ [Nm]	P ₁ [kW]	FS'	Input - IEC			
								B5/B14			
Kg 6.6	5	100	0.85	—	20	0.25	8.3	90	80	—	
	7.5	67	0.83		30	0.25	5.9				
	10	50	0.81		39	0.25	4.7				
	15	33	0.76		55	0.25	3.4				
	20	25	0.74		71	0.25	2.8				
	25	20	0.71		85	0.25	1.9				
	30	17	0.65		94	0.25	2.1	—	71		
	40	13	0.62		118	0.25	1.7				
	50	10	0.56		135	0.25	1.2				
	65	8	0.52		163	0.25	1.0				
	80	6	0.50		137	0.18	1.1				
	100	5	0.45		77	0.09	1.6				

* **ATTENZIONE:** la coppia massima utilizzabile [T_{2M}] deve essere calcolata utilizzando il fattore di servizio: T_{2M} = T₂ x FS'

* **WARNING:** Maximum allowable torque [T_{2M}] must be calculated using the following service factor : T_{2M} = T₂ x FS'

* **ACHTUNG:** das max. anwendbare Drehmoment [T_{2M}] muss mit folgendem Betriebsfaktor berechnet werden: T_{2M} = T₂ x FS'

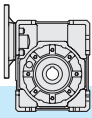

5.10 Dati tecnici

5.10 Technical data

5.10 Technische Daten

GXC 75	$n_1 = 2800$				MOTORI / MOTORS / ENGINE GHA CLASSIC							
	i_n	n_2 [min ⁻¹]	Rd	P_{t0}	T_2 [Nm]	P_1 [kW]	FS'	Input - IEC B5/B14				
					112		100		90		80	
Kg 9.5	7.5	373	0.89	—	125	5.5	1.0	112	100	90	—	—
	10	280	0.88		120	4	1.2					
	15	187	0.85		131	3	1.2					
	20	140	0.84		171	3	1.0					
	25	112	0.82		154	2.2	1.0					
	30	93	0.78		120	1.5	1.4					
	40	70	0.75		154	1.5	1.2	—	80	71		
	50	56	0.73		136	1.1	1.2					
	65	43	0.69		114	0.75	1.4					
	80	35	0.66		135	0.75	1.1					
	100	28	0.62		159	0.75	0.8					

GXC 75	$n_1 = 1400$				MOTORI / MOTORS / ENGINE GHA CLASSIC							
	i_n	n_2 [min ⁻¹]	Rd	P_{t0}	T_2 [Nm]	P_1 [kW]	FS'	Input - IEC B5/B14				
					112		100		90		80	
Kg 9.5	7.5	187	0.87	2.5	178	4	1.0	112	100	90	—	—
	10	140	0.86	2.3	176	3	1.1					
	15	93	0.83	1.9	187	2.2	1.1					
	20	70	0.81	1.7	199	1.8	1.1					
	25	56	0.78	1.5	200	1.5	1.0					
	30	47	0.74	1.2	167	1.1	1.3					
	40	35	0.71	1.1	213	1.1	1.1	—	80	71		
	50	28	0.67	1.0	206	0.9	1.0					
	65	22	0.63	0.90	154	0.55	1.3					
	80	18	0.60	0.80	180	0.55	1.0					
	100	14	0.56	0.70	210	0.55	0.8					

GXC 75	$n_1 = 900$				MOTORI / MOTORS / ENGINE GHA CLASSIC							
	i_n	n_2 [min ⁻¹]	Rd	P_{t0}	T_2 [Nm]	P_1 [kW]	FS'	Input - IEC B5/B14				
					112		100		90		80	
Kg 9.5	7.5	120	0.86	—	205	3	1.0	112	100	90	—	—
	10	90	0.84		197	2.2	1.2					
	15	60	0.81		231	1.8	1.0					
	20	45	0.78		250	1.5	1.1					
	25	36	0.76		221	1.1	1.1					
	30	30	0.71		249	1.1	1.0					
	40	23	0.67		214	0.75	1.3	—	80	71		
	50	18	0.64		186	0.55	1.3					
	65	14	0.59		151	0.37	1.5					
	80	11	0.56		177	0.37	1.2					
	100	9	0.52		203	0.37	0.9					

GXC 75	$n_1 = 500$				MOTORI / MOTORS / ENGINE GHA CLASSIC							
	i_n	n_2 [min ⁻¹]	Rd	P_{t0}	T_2 [Nm]	P_1 [kW]	FS'	Input - IEC B5/B14				
					112		100		90		80	
Kg 9.5	7.5	67	0.84	—	90	0.75	2.9	112	100	90	—	—
	10	50	0.82		118	0.75	2.4					
	15	33	0.78		167	0.75	1.7					
	20	25	0.75		216	0.75	1.5					
	25	20	0.72		260	0.75	1.1					
	30	17	0.67		288	0.75	1.1					
	40	13	0.63		265	0.55	1.2	—	80	71		
	50	10	0.59		210	0.37	1.3					
	65	8	0.55		251	0.37	1.0					
	80	6	0.52		197	0.25	1.2					
	100	5	0.47		161	0.18	1.3					

* **ATTENZIONE:** la coppia massima utilizzabile $[T_{2M}]$ deve essere calcolata utilizzando il fattore di servizio: $T_{2M} = T_2 \times FS'$

* **WARNING:** Maximum allowable torque $[T_{2M}]$ must be calculated using the following service factor: $T_{2M} = T_2 \times FS'$

* **ACHTUNG:** das max. anwendbare Drehmoment $[T_{2M}]$ muss mit folgendem Betriebsfaktor berechnet werden: $T_{2M} = T_2 \times FS'$

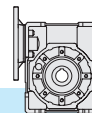



5.10 Dati tecnici

5.10 Technical data

5.10 Technische Daten

GXC 89	$n_1 = 2800$				MOTORI / MOTORS / ENGINE GHA CLASSIC							
	i_n	n_2 [min ⁻¹]	Rd	P_{10}	T_2 [Nm]	P_1 [kW]	FS'	Input - IEC				
								B5/B14				
 23.6	7.5	373	0.89	—	171	7.5	1.2	112 100	90	—		
	10	280	0.88		165	5.5	1.3					
	15	187	0.86		241	5.5	1.0					
	20	140	0.84		230	4	1.2					
	25	112	0.83		212	3	1.2					
	30	93	0.79		243	3	1.1					
	40	70	0.77		230	2.2	1.3	—	80			
	50	56	0.74		278	2.2	1.0					
	65	43	0.71		235	1.5	1.1					
	80	35	0.68		205	1.1	1.2					
100	28	0.64	163	0.75	1.3							

GXC 89	$n_1 = 1400$				MOTORI / MOTORS / ENGINE GHA CLASSIC							
	i_n	n_2 [min ⁻¹]	Rd	P_{10}	T_2 [Nm]	P_1 [kW]	FS'	Input - IEC				
								B5/B14				
 23.6	7.5	187	0.88	3.0	247	5.5	1.2	112 100	90	—		
	10	140	0.86	2.5	236	4	1.3					
	15	93	0.84	2.2	256	3	1.2					
	20	70	0.82	2.0	334	3	1.1					
	25	56	0.80	1.8	299	2.2	1.1					
	30	47	0.76	1.5	340	2.2	1.0	—	80			
	40	35	0.72	1.3	355	1.8	1.1					
	50	28	0.69	1.1	353	1.5	1.0					
	65	22	0.65	1.0	317	1.1	1.0					
	80	18	0.63	1.0	309	0.9	1.0					
100	14	0.58	0.80	217	0.55	1.2						

GXC 89	$n_1 = 900$				MOTORI / MOTORS / ENGINE GHA CLASSIC							
	i_n	n_2 [min ⁻¹]	Rd	P_{10}	T_2 [Nm]	P_1 [kW]	FS'	Input - IEC				
								B5/B14				
 23.6	7.5	120	0.86	—	206	3	1.7	112 100	90	—		
	10	90	0.85		270	3	1.3					
	15	60	0.82		286	2.2	1.3					
	20	45	0.79		371	2.2	1.1					
	25	36	0.77		369	1.8	1.0					
	30	30	0.73		416	1.8	1.0					
	40	23	0.69		440	1.5	1.0	—	80			
	50	18	0.66		384	1.1	1.0					
	65	14	0.62		319	0.75	1.1					
	80	11	0.59		274	0.55	1.2					
100	9	0.54	313	0.55	1.0							

GXC 89	$n_1 = 500$				MOTORI / MOTORS / ENGINE GHA CLASSIC							
	i_n	n_2 [min ⁻¹]	Rd	P_{10}	T_2 [Nm]	P_1 [kW]	FS'	Input - IEC				
								B5/B14				
 23.6	7.5	67	0.84	—	91	0.75	4.7	112 100	90	—		
	10	50	0.83		118	0.75	3.7					
	15	33	0.79		169	0.75	2.7					
	20	25	0.76		219	0.75	2.3					
	25	20	0.74		265	0.75	1.7					
	30	17	0.68		294	0.75	1.6					
	40	13	0.65		371	0.75	1.4	—	80			
	50	10	0.61		439	0.75	1.1					
	65	8	0.57		388	0.55	1.1					
	80	6	0.54		305	0.37	1.3					
100	5	0.49	344	0.37	1.0							

* **ATTENZIONE:** la coppia massima utilizzabile $[T_{2M}]$ deve essere calcolata utilizzando il fattore di servizio: $T_{2M} = T_2 \times FS'$

* **WARNING:** Maximum allowable torque $[T_{2M}]$ must be calculated using the following service factor: $T_{2M} = T_2 \times FS'$

* **ACHTUNG:** das max. anwendbare Drehmoment $[T_{2M}]$ muss mit folgendem Betriebsfaktor berechnet werden: $T_{2M} = T_2 \times FS'$

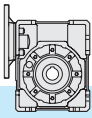

5.11 **Momenti d'inerzia** [Kg·cm²]
(riferiti all'albero veloce in entrata)

5.11 **Moments of inertia** [Kg·cm²]
(referred to input shaft)

5.11 **Trägheitsmoment** [Kg·cm²]
(bez. Antriebswelle)

GX30	i _n	GXC	
		B5 - B14	
		IEC 56	IEC 63
5		0.130	0.127
7.5		0.112	0.109
10		0.103	0.100
15		0.097	0.094
20		0.095	0.092
25		0.094	0.091
30		0.093	0.090
40		0.093	0.090
50		0.092	0.089
65		0.079	-
80		0.079	-
100		0.078	-

GX63	i _n	GXC		
		B5 - B14		
		IEC 71	IEC 80	IEC 90
5		-	2.431	2.671
7.5		-	1.949	2.269
10		-	1.744	2.063
15		-	1.597	1.916
20		-	1.545	1.864
25		-	1.514	1.833
30		-	1.508	1.828
40		0.966	1.495	-
50		0.959	1.488	-
65		0.955	1.484	-
80		0.953	1.482	-
100		0.952	1.481	-

GX40	i _n	GXC		
		B5 - B14		
		IEC 56	IEC 63	IEC 71
5		-	0.391	0.463
7.5		-	0.321	0.356
10		-	0.272	0.347
15		-	0.266	0.340
20		-	0.263	0.338
25		-	0.262	0.337
30		-	0.262	0.337
40		-	0.261	0.336
50		0.182	0.261	-
65		0.182	0.261	-
80		0.182	0.261	-
100		0.182	0.261	-

GX75	i _n	GXC			
		B5 - B14			
		IEC 71	IEC 80	IEC 90	IEC 100-112
7.5		-	-	3.712	4.462
10		-	-	3.234	3.984
15		-	-	2.893	3.643
20		-	-	2.774	3.523
25		-	-	2.709	3.458
30		1.615	1.575	2.689	3.438
40		-	1.573	2.659	-
50		-	1.570	2.642	-
65		1.609	1.569	2.633	-
80		1.605	1.565	2.629	-
100		1.602	1.562	2.626	-

GX50	i _n	GXC		
		B5 - B14		
		IEC 63	IEC 71	IEC 80
5		-	0.922	1.046
7.5		-	0.684	0.935
10		-	0.602	0.853
15		-	0.543	0.794
20		-	0.523	0.774
25		-	0.513	0.764
30		-	0.508	0.759
40		0.315	0.503	0.755
50		0.313	0.501	-
65		0.311	0.499	-
80		0.310	0.498	-
100		0.309	0.498	-

GX89	i _n	GXC		
		B5 - B14		
		IEC 80	IEC 90	IEC 100-112
7.5		-	6.898	7.671
10		-	5.875	6.648
15		-	5.144	5.917
20		-	3.398	5.661
25		-	3.256	5.520
30		-	3.215	5.479
40		-	3.151	-
50		-	3.115	-
65		2.024	3.096	-
80		2.014	3.087	-
100		2.008	3.080	-

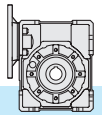

5.12 Dimensioni

5.12 Dimensions

5.12 Abmessungen

GXC

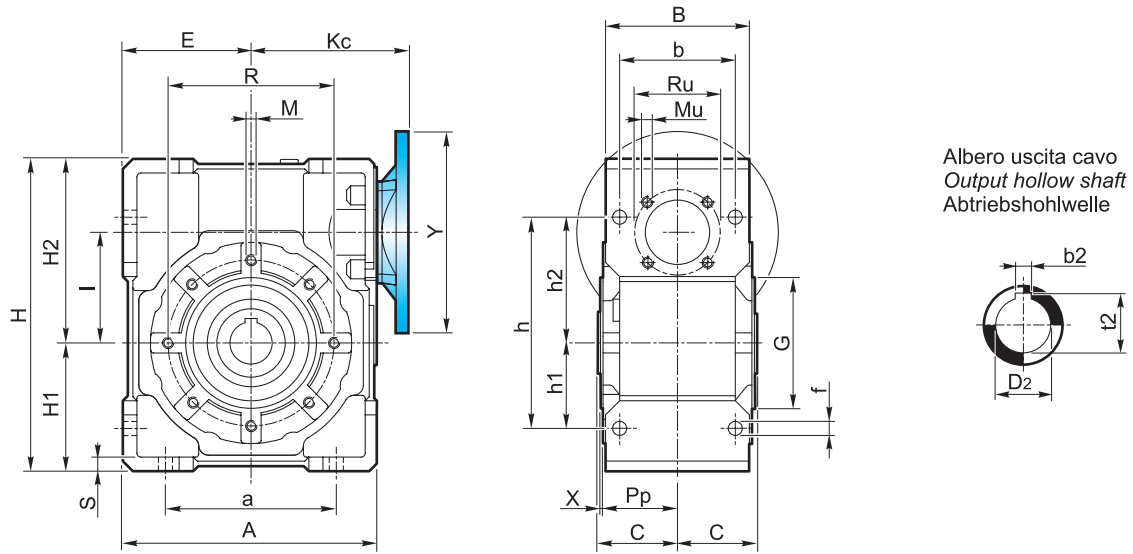

Flangia pendolare / Shaft-mounted flange / Aufsteckflansch

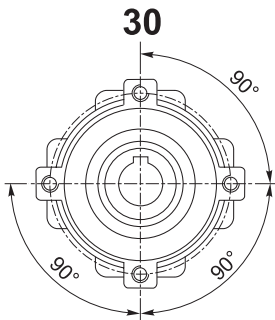

4 Fori / Holes / Bohrungen

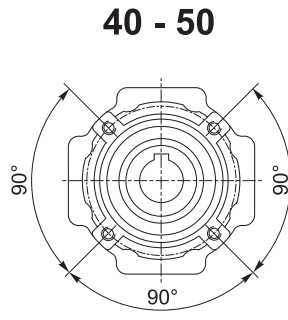

4 Fori / Holes / Bohrungen

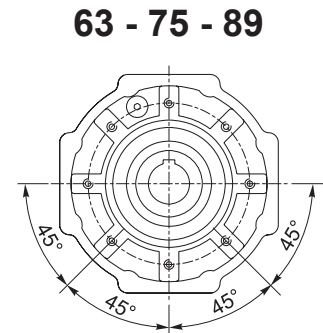

8 Fori / Holes / Bohrungen

GX	A	a	B	b	b ₂	C	D ₂ H ₈	E	f	G h ₈	H	H ₁	H ₂	h	h ₁	h ₂
30	80	54	56	44	5	31.5	14	40	6.5	55	97	40	57	71	27	44
40	105	70	71	60	6	39	18	50	6.5	60	125	50	75	90	35	55
50	125	80	85	70	8	46	25	60	8.5	70	150	60	90	104	40	64
63	147	100	103	85	8	56	25	72	9	80	182	72	110	130	50	80
75	176	120	112	90	8	60	28	86	11	95	219.5	86	133.5	153	60	93
89	203	140	130	100	10	70	35	103	13	110	248.5	103	145.5	172	70	102

GX	I	K _c	L	M	M _u	P _p	R	Ru	S	t ₂	X
30	31.5	57	15	M6x8	M5x7.5	29	65	35.4	5.5	16.3	1.5
40	40	75	20	M6x10	M5x10	36.5	75	42.4	6	20.8	1.5
50	50	82	25	M8x10	M6x10	43.5	85	53.7	7	28.3	1.5
63	63	95	30	M8x14	M6x12	53	95	60.8	8	28.3	2
75	75	112 - 110 ⁽¹⁾	40	M8x14	M8x12	57	115	70.7	10	31.3	2
89	90	122	40	M10x18	M8x14	67	130	70.7	12	38.3	2

(1): Solo per PAM 71B14 / Only for PAM 71B14 / Nur PAM 71B14

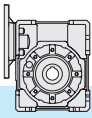

5.12 Dimensioni

5.12 Dimensions

5.12 Abmessungen

Flangia uscita / Output flange / Abtriebsflansch

Vista da A / View from A / Ansicht von A

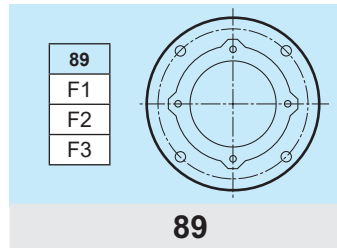
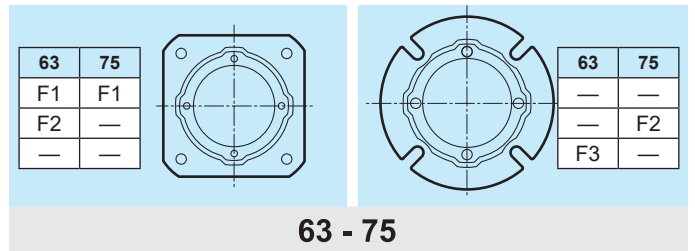
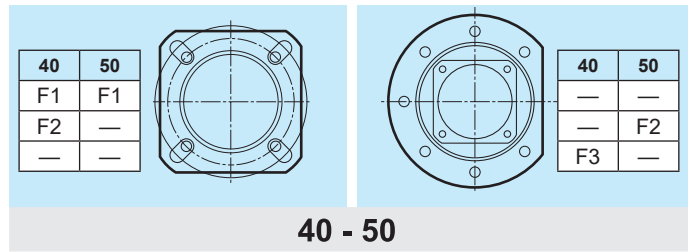
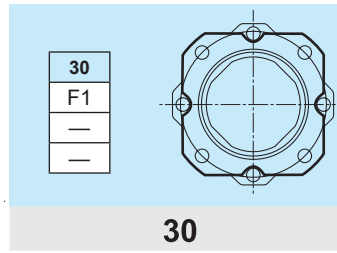
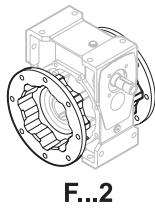
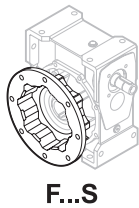
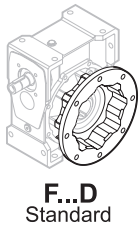
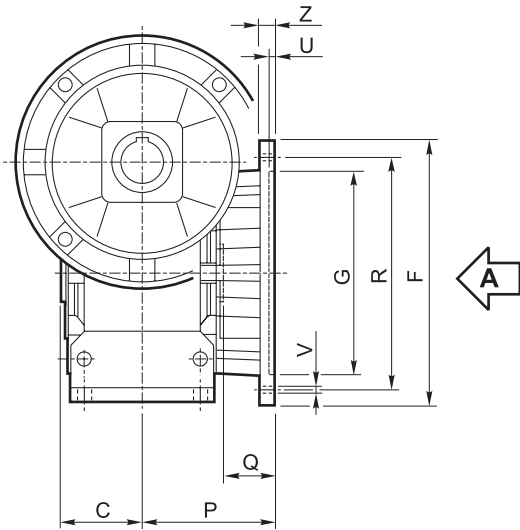

Tipo Type Typ	C	F		G H8	P	Q	R	U	V			Z
											Ø	
30	31.5		66	50	54.5	23	68	4	n° 4		6.5	6
40	39		85	60	67	28	75-90	4	n° 4		9	8
			85	60	97	58	75-90	4	n° 4		9	8
		140		95	80	41	115	5		n° 7	9	10
50	46		94	70	90	44	85-100	5	n° 4		11	10
		160		110	89	43	130	5		n° 7	11	11
63	56		142	115	82	26	150	5	n° 4		11	11
			142	115	112	56	150	5	n° 4		11	11
		160		110	80.5	24.5	130	5	n° 4		11	12
75	60		160	130	111	51	165	5	n° 4		13	12
		160		110	90	30	130	6	n° 4		11	13
89	70	200		152	111	41	175	5	n° 4		13	12
		200		152	151	81	175	5	n° 4		13	13
		200		130	110	40	165	6	n° 4		11	11

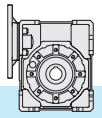
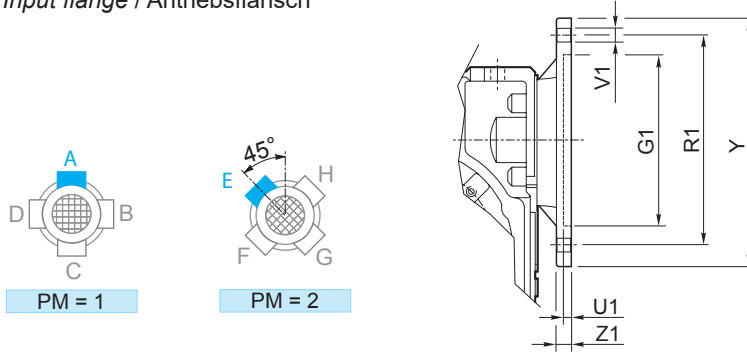

5.12 Dimensioni
5.12 Dimensions
5.12 Abmessungen
Flangia entrata / Input flange / Antriebsflansch

GXC	IEC	G ₁	PM		R ₁	U ₁	V ₁			Y	Z ₁	Diametro fori PAM / Holes diameter IEC / IEC Durchmesser												
			1	2			Ø						5	7.5	10	15	20	25	30	40	50	65	80	100
			30	56 B5			80	• •	100			4	7	8			8	9	9	9	9	9	9	9
56 B14	50	• •		65	3.5	6	8		80	8	9	9	9	9	9	9	9	9	9	9	9	9	9	
63 B5	95	• •		115	4	9	8		140	8	11	11	11	11	11	11	11	11	11	/	/	/	/	
63 B14	60	• •		75	4	6	8		90	8	11	11	11	11	11	11	11	11	11	/	/	/	/	
40	56 B5	80	• •	100	4	7	8		120	9	/	/	/	/	/	/	/	/	9	9	9	9	9	
	56 B14	50	•	65	3.5	6		4	80	8	/	/	/	/	/	/	/	/	9	9	9	9	9	
	63 B5	95	• •	115	4	9	8		140	9	11	11	11	11	11	11	11	11	11	11	11	11	11	
	63 B14	60	•	75	3.5	6		4	90	8	11	11	11	11	11	11	11	11	11	11	11	11	11	
	71 B5	110	• •	130	4.5	9	8		160	10	14	14	14	14	14	14	14	14	/	/	/	/	/	
	71 B14	70	• •	85	3.5	7	8		105	8	14	14	14	14	14	14	14	14	/	/	/	/	/	
50	63 B5	95	• •	115	4	9	8		140	9	/	/	/	/	/	/	/	11	11	11	11	11	11	
	63 B14	60	•	75	3.5	6		4	90	8	/	/	/	/	/	/	/	11	11	11	11	11	11	
	71 B5	110	• •	130	4.5	9	8		160	10	14	14	14	14	14	14	14	14	14	14	14	14	14	
	71 B14	70	•	85	3.5	7		4	105	8	14	14	14	14	14	14	14	14	14	14	14	14	14	
	80 B5	130	• •	165	4.5	11	8		200	10	19	19	19	19	19	19	19	19	/	/	/	/	/	
	80 B14	80	• •	100	4	7	8		120	10	19	19	19	19	19	19	19	19	/	/	/	/	/	
63	71 B5	110	• •	130	4.5	9	8		160	10	/	/	/	/	/	/	/	14	14	14	14	14	14	
	71 B14	70	•	85	3.5	7		4	105	10	/	/	/	/	/	/	/	14	14	14	14	14	14	
	80 B5	130	• •	165	4.5	11	8		200	10	19	19	19	19	19	19	19	19	19	19	19	19	19	
	80 B14	80	•	100	4	7		4	120	10	19	19	19	19	19	19	19	19	19	19	19	19	19	
	90 B5	130	• •	165	4.5	11	8		200	10	24	24	24	24	24	24	24	24	/	/	/	/	/	
	90 B14	95	• •	115	4	8.5	8		140	10	24	24	24	24	24	24	24	24	/	/	/	/	/	
75	71 B5	110	• •	130	4.5	9	8		160	10	/	/	/	/	/	/	/	14	/	/	14	14	14	
	71 B14	70	•	85	4	7		4	105	11	/	/	/	/	/	/	/	14	/	/	14	14	14	
	80 B5	130	• •	165	4.5	11	8		200	10	/	/	/	/	/	/	/	19	19	19	19	19	19	
	80 B14	80	•	100	4	7		4	120	11	/	/	/	/	/	/	/	19	19	19	19	19	19	
	90 B5	130	• •	165	4.5	11	8		200	10	/	24	24	24	24	24	24	24	24	24	24	24	24	
	90 B14	95	•	115	4	9		4	140	11	/	24	24	24	24	24	24	24	24	24	24	24	24	
	100/112 B5	180	• •	215	5	14	8		250	13	/	28	28	28	28	28	28	28	/	/	/	/	/	
100/112 B14	110	• •	130	4.5	9	8		160	11	/	28	28	28	28	28	28	28	/	/	/	/	/		
89	80 B5	130	• •	165	4.5	11	8		200	10	/	/	/	/	/	/	/	/	/	19	19	19	19	
	80 B14	80	•	100	4	7		4	120	11	/	/	/	/	/	/	/	/	/	19	19	19	19	
	90 B5	130	• •	165	4.5	11	8		200	10	/	24	24	24	24	24	24	24	24	24	24	24	24	
	90 B14	95	•	115	4	9		4	140	11	/	24	24	24	24	24	24	24	24	24	24	24	24	
	100/112 B5	180	• •	215	5	14	8		250	13	/	28	28	28	28	28	28	28	/	/	/	/	/	
	100/112 B14	110	• •	130	4.5	9	8		160	11	/	28	28	28	28	28	28	28	/	/	/	/	/	

N.B.: Il montaggio STD di P_M=2 solo quando non è possibile il montaggio STD di P_M=1.
 N.B.: E' possibile realizzare anche tutte le composizioni ibride ottenibili dalle flange esistenti.

N.B.: STD mounting of P_M=2 only if STD mounting of P_M=1 is not possible.
 N.B.: it is possible to create hybrid combinations with the existing flanges.

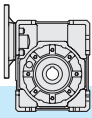
ANMERKUNG: STD Montage von P_M=2 nur wenn STD Montage von P_M=1 unmöglich ist.
 ANMERKUNG: Mischkombinationen mit der verfügbaren Flanschen sind möglich.



5.13 Entrata supplementare
(vite bisporgente)

5.13 Additional input
(double extended shaft)

5.13 Zusatzantrieb
(beidseitige Welle)

S.e.A.

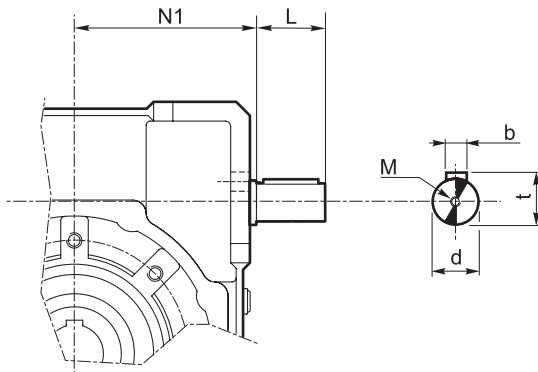

GX	d j6	L	M	N1	b	t
30	9	15	M4x10	42.5	3	10.2
40	11	20	M4x12	52.5	4	12.5
50	14	25	M5x13	62.5	5	16
63	19	30	M8x20	74.5	6	21.5
75	24	40	M8x20	91	8	27
89	24	40	M8x20	108	8	27

5.14 Accessori
(braccio di reazione)

5.14 Accessories
(Torque arm)

5.14 Zubehör
(Drehmomentstütze)

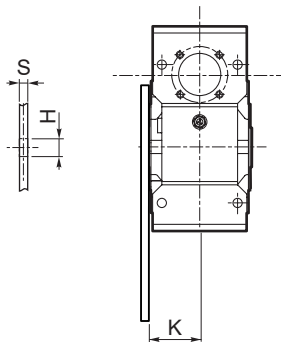
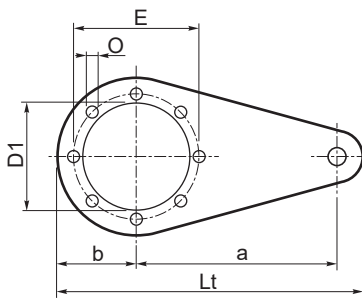

GX	a	b	D ₁	E	H	K	L _t	O	S1	S2
30	85	37.5	55	65	8	24	141.5	7	14	4
40	100	45	60	75	10	31.5	167	7	14	4
50	100	50	70	85	10	39	172	9	14	5
63	150	55	80	95	10	49	227	9	14	6
75	200	70	95	115	20	47.5	302	9	25	6
89	200	80	110	130	20	57.5	312	11	25	6

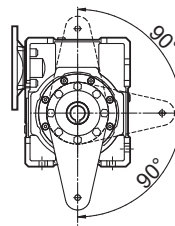

30 - 40 - 50

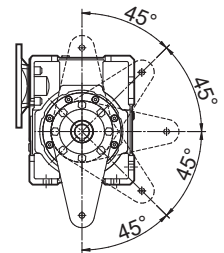

63 - 75 - 89

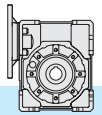

5.15 Lista parti di ricambio

In fase di ordine delle parti di ricambio, specificare sempre n° particolare (vedi disegno esploso), data (1), n° codice (2) e n° variante (3).
(Vedi targhetta).

5.15 Spare parts list

When ordering a spare part, the spare part number (see exploded technical drawing), the date (1), the code number (2) and the variant number (3) should always be reported.
(See plate)

5.15 Ersatzteilliste

Bei der Bestellung von Ersatzteilen sind Ersatzteilnummer (s. Explosionszeichnung), Datum (1), Artikelnummer (2) und Variantennummer (3) anzugeben.
(s. Schild)

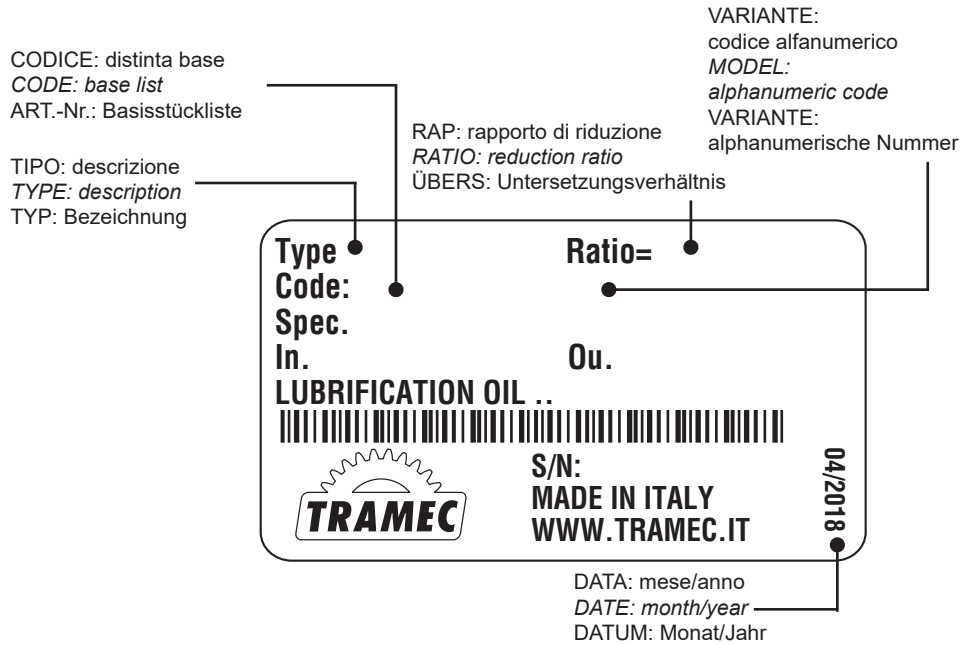

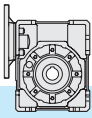

GXC

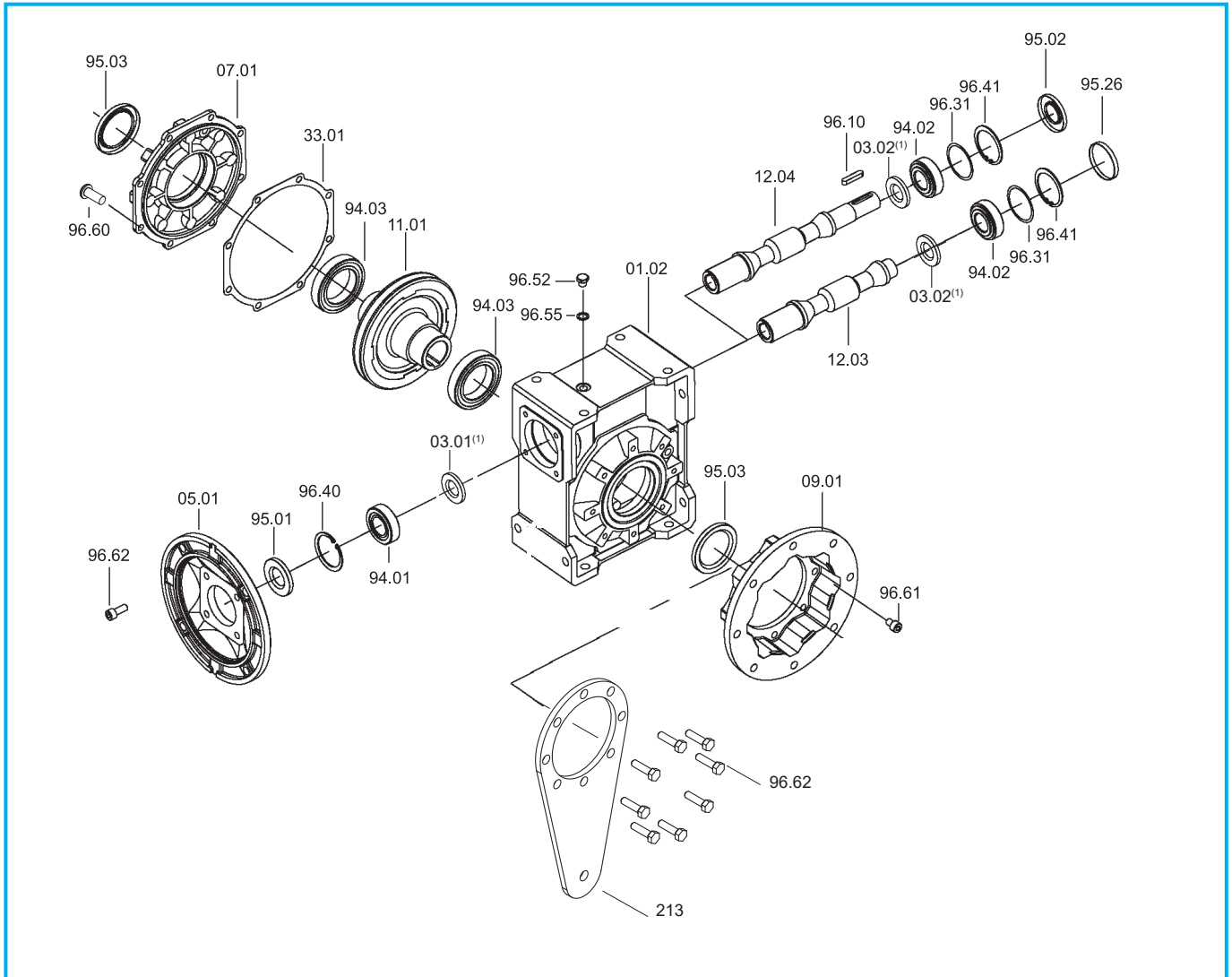

GX	IEC	Cuscinetti / Bearings / Lager			Anelli di tenuta / Oilseals Öldichtungen			Cappello / Closed oil seal Geschlossene Öldichtung
		94.01	94.02	94.03	95.01	95.02	95.03	95.26
30	56	61804 (20x32x7)	6000 10x26x8	6005 25x47x12	20/32/5	10/26/7	25/40/7	ø 26x7
	63	61804 (20x32x7)			20/32/5			
40	56	6303 (17x47x14)	6201 12x32x10	6006 30x55x13	17/47/7	12/32/7	30/47/7	ø 32x7
	63	6204 (20x47x14)			20/47/7			
	71	6005 (25x47x12)			25/47/7			
50	63	6204 (20x47x14)	6203 17x40x12	6008 40x68x15	20/47/7	17/40/7	40/62/8	ø 40x7
	71	6005 (25x47x12)			25/47/7			
	80	6006 (30x55x13)			30/55/7			
63	71	6305 (25x62x17)	6204 C3 20x47x14	6008 40x68x15	25/62/7	20/47/7	40/62/8	ø 47x7
	80	6206 (30x62x16)			30/62/7			
	90	6007 (35x62x14)			35/62/7			
75	71	6206 (30x62x16)	6205 C3 25x52x15	6010 50x80x16	30/62/7	25/52/7	50/72/8	ø 52x7
	80	6206 (30x62x16)			30/62/7			
	90	6007 (35x62x14)			35/62/7			
	100/112	6008 (40x68x15)			40/68/10			
89	80	6206 (30x62x16)	6205 C3 25x52x15	6010 50x80x16	30/62/7	25/52/7	50/72/8	ø 52x7
	90	6007 (35x62x14)			35/62/7			
	100/112	6008 (40x68x15)			40/68/10			

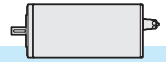

6.0	MOTORI MHA PREMIUM	MHA PREMIUM MOTORS	ENGINES MHA PREMIUM	
6.1	Caratteristiche	<i>Characteristics</i>	Merkmale	98
6.2	Dati tecnici	<i>Technical data</i>	Technische Daten	99
6.3	Dimensioni	<i>Dimensions</i>	Abmessungen	99

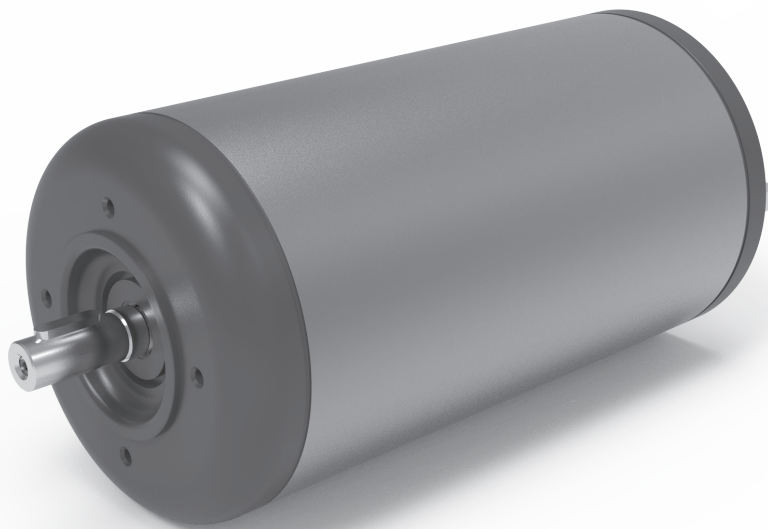



6.1 Caratteristiche

La nuova gamma GHA include i motori MHA PREMIUM (classe energetica IE4) dotati, analogamente ai riduttori della serie GHA PREMIUM, di carcassa in lega di alluminio sottoposta a trattamento G.H.A. potenziato.

Il corpo di questi motori presenta, inoltre, uno speciale profilo esterno liscio appositamente progettato per consentirne la massima pulizia.

Ideale complemento dei riduttori GHA PREMIUM, i motori MHA PREMIUM presentano le seguenti caratteristiche speciali, che si sommano alle caratteristiche NANOTECHNOLOGICHE già descritte per i riduttori GHA PREMIUM (eccellenti proprietà antibatteriche e anticorrosive):

- Dissipazione termica superiore al 35% rispetto alla versione senza trattamento G.H.A.
- Maggiore efficienza del motore, in virtù della maggiore dissipazione termica
- Capacità di sopportare elevati voltaggi, grazie alle caratteristiche amagnetiche

In virtù delle loro speciali caratteristiche, i motori MHA PREMIUM costituiscono la soluzione ideale per applicazioni in campo ALIMENTARE (non a contatto con gli alimenti), FARMACEUTICO e MARINO.

6.1 Caratteristiche

Similarly to the GHA PREMIUM series reducers, the new GHA range includes MHA PREMIUM motors (energy class IE4) equipped with an aluminium alloy casing subjected to enhanced G.H.A. treatment.

The body of these motors also has a special smooth external profile specially designed to allow for maximum cleanliness.

The ideal complement to GHA PREMIUM reducers is the MHA PREMIUM motor that has the following special features, which are added to the NANOTECHNOLOGICAL characteristics already described for the GHA PREMIUM reducers (excellent bactericidal and anticorrosive properties):

- *Thermal dissipation 35% greater than the version without G.H.A. treatment*
- *Greater motor efficiency thanks to the higher heat dissipation*
- *Ability to withstand high voltages, thanks to the non-magnetic characteristics*

Thanks to their special characteristics, MHA PREMIUM motors are the ideal solution for applications in the FOOD (not in contact with food), PHARMACEUTICAL and MARINE SECTORS.

6.1 Caratteristiche

Die neue GHA-Serie umfasst auch die Motoren MHA PREMIUM (Effizienzklasse IE4), die genau wie die Getriebe der Serie GHA PREMIUM mit einem Aluminiumgehäuse ausgestattet sind, das einer verstärkten G.H.A.-Behandlung unterzogen wurde.

Das Gehäuse dieser Motoren weist ein spezielles, glattes Außenprofil auf, das eigens dafür entwickelt wurde, um die bestmögliche Reinigung zu gewährleisten.

Die Motoren MHA PREMIUM sind die ideale Ergänzung zu den Getrieben GHA PREMIUM und weisen die folgenden speziellen Merkmale auf, die zu den für die Getriebe GHA PREMIUM bereits beschriebenen NANOTECHNOLOGISCHEN Merkmalen (ausgezeichnete bakterientötende Wirkung und Korrosionsbeständigkeit) hinzu kommen:

- Um mehr als 35 % gesteigerte Wärmeableitung im Vergleich zu den Ausführungen ohne G.H.A.-Behandlung
- Höhere Leistungsfähigkeit des Motors dank der besseren Wärmeableitung
- Fähigkeit hohe Stromstärken auszuhalten dank den nichtmagnetischen Merkmalen

Dank ihren speziellen Merkmalen sind die Motoren MHA PREMIUM die ideale Lösung für Anwendungen in der Lebensmittel- (ohne Kontakt mit den Lebensmitteln), Pharma- und Schifffahrtsbranche.

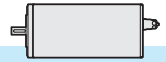

6.2 Dati tecnici

6.2 Technical data

6.2 Technische Daten

IE4	4 POLI / 4 POLES / 4 POLIG								
	P _n (kW)	n ₁ (rpm)	η % 100% P _n	cos φ	I _n (A)	T _n (Nm)	$\frac{T_{sp}}{T_n}$	$\frac{I_{sp}}{I_n}$	 Kg
MHA 63 AS MHA 63 AM	0.13	1400	70.9	0.73	0.38	0.88	3.6	6.5	8.8
MHA 63 BS MHA 63 BM	0.18	1420	74.5	0.73	0.48	1.25	3.78	6.4	9.5
MHA 71 AS MHA 71 AM	0.25	1440	77.9	0.81	0.56	1.7	3.7	7.2	13
MHA 71 BS MHA 71 BM	0.37	1440	81.1	0.79	0.83	2.44	4.63	8.34	14.5
MHA 80 AS MHA 80 AM	0.5	1450	83.2	0.71	1.24	3.3	5.25	8.43	18
MHA 80 BS MHA 80 BM	0.75	1450	85.7	0.72	1.77	4.95	5.8	8.52	19
MHA 90 AS	1.1	1440	87.2	0.79	2.28	7.3	4.2	8.9	25
MHA 90 BS	1.5	1460	88.2	0.77	3.16	9.85	4.9	10.0	32

ATTENZIONE: I dati tecnici riportati nelle tabelle si riferiscono ad una tensione di alimentazione di 230/400 V, 50 Hz.

WARNING: Technical data are referred to voltage 230/400V, 50Hz.

ACHTUNG: Technische Daten beziehen sich auf Spannung 230/400V, 50Hz.

6.3 Dimensioni

6.3 Dimensions

6.3 Abmessungen

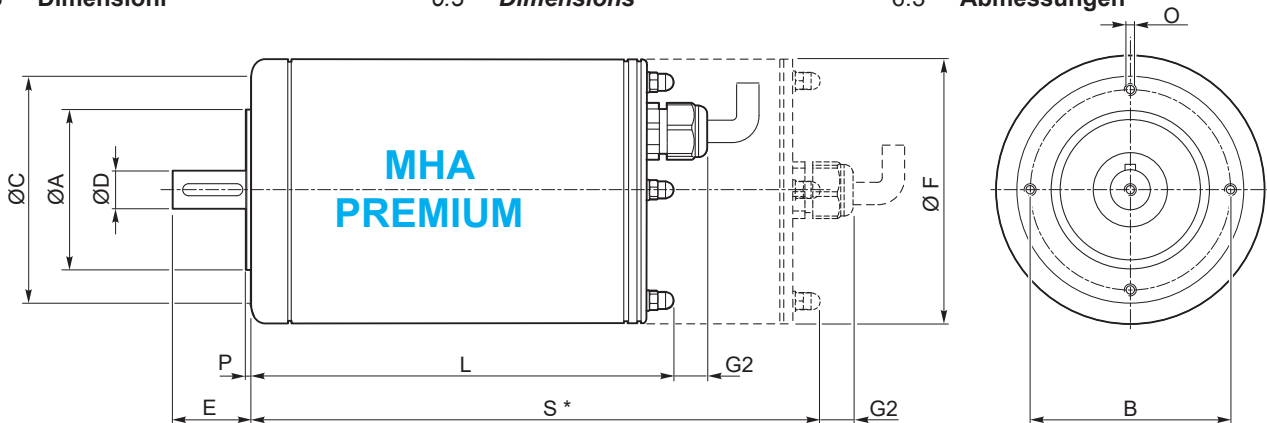

*S: quota valida solo per le versioni a richiesta (freno, encoder, ecc.).

*S: value valid only for the versions on request (brake, encoder, ecc.).

*S: Wert gilt nur für die Versionen auf Anfrage (Bremse, Encoder, ecc.).

MHA	IEC B14										
	A j ₆	B	C	IEC B14	D j ₆	E	F	G2	L	O	P
63 AS 63 BS	60	75	90	63	11	23	118	16 ⁽¹⁾	235	M5	2
63 AM 63 BM	70	85	105	71	14	30	118		235	M6	2.5
71 AS 71 BS	70	85	105	71	14	30	134		246	M6	2.5
71 AM 71 BM	80	100	120	80	19	40	134		246	M6	3
80 AS 80 BS	80	100	120	80	19	40	150		271	M6	3
80 AM 80 BM	95	115	140	90	24	50	150		271	M8	3
90 AS 90 BS	95	115	140	90	24	50	190		339	M8	3

(1): con pressacavo standard

(1): with standard cable gland

(1): mit Standard-Klemmenkasten

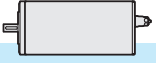

GHA - CLASSIC

La nuova gamma GHA include anche i motori GHA CLASSIC (classe energetica IE1 e IE3) che, analogamente ai riduttori della serie GHA CLASSIC, sono dotati di carcassa in lega di alluminio sottoposta a trattamento G.H.A. standard.

Le carcasse sono del tipo classico alettato, disponibili nelle versioni B5 e B14.

Questi motori, ideale complemento dei riduttori delle serie GHA CLASSIC e GHA MODULAR, presentano le seguenti caratteristiche speciali che si sommano alle caratteristiche NANOTECCNOLOGICHE già descritte per i riduttori GHA CLASSIC e GHA MODULAR (eccellenti proprietà antibatteriche, resistenza standard alla corrosione):

- Dissipazione termica superiore al 35% rispetto alla versione senza trattamento G.H.A.
- Maggiore efficienza del motore, in virtù della maggiore dissipazione termica
- Capacità di sopportare elevati voltaggi, grazie alle caratteristiche amagnetiche

In virtù delle loro speciali caratteristiche, i motori GHA CLASSIC sono particolarmente idonei per applicazioni in campo ALIMENTARE (non a contatto con gli alimenti), FARMACEUTICO.

GHA - CLASSIC

The new GHA range also includes GHA CLASSIC motors (energy class IE1 and IE3) which, like the GHA CLASSIC series reducers, are fitted with an aluminium alloy casing subjected to standard G.H.A. treatment.

The casings are of the classic finned type, available in versions B5 and B14.

These motors are the ideal complement to GHA CLASSIC and GHA MODULAR series reducers and feature the following special characteristics on top of the NANOTECHNOLOGICAL characteristics already described for the GHA CLASSIC and GHA MODULAR reducers (excellent antibacterial properties and standard corrosion resistance):

- Thermal dissipation 35% greater than the version without G.H.A. treatment
- Greater motor efficiency thanks to the higher heat dissipation
- Ability to withstand high voltages, thanks to the non-magnetic characteristics

Thanks to their special characteristics, GHA CLASSIC motors are particularly suitable for applications in the FOOD (not in contact with food), PHARMACEUTICAL sectors.

GHA - CLASSIC

Die neue GHA-Serie umfasst auch die Motoren GHA PREMIUM (Effizienzklasse IE1 und IE3), die genau wie die Getriebe der Serie GHA CLASSIC mit einem Aluminiumgehäuse ausgestattet sind, das der standardmäßigen G.H.A.-Behandlung unterzogen wurde.

Die klassischen Rippengehäuse sind in den Ausführungen B5 und B14 erhältlich.

Diese Motoren sind die ideale Ergänzung zu den Getriebe GHA CLASSIC und GHA MODULAR und weisen die folgenden speziellen Merkmale auf, die zu den für die Getriebe GHA CLASSIC und GHA MODULAR bereits beschriebenen NANOTECHNOLOGISCHEN Merkmalen (ausgezeichnete antibakterielle Wirkung und standardmäßige Korrosionsbeständigkeit) hinzu kommen:

- Um mehr als 35 % gesteigerte Wärmeableitung im Vergleich zu den Ausführungen ohne G.H.A.-Behandlung
- Höhere Leistungsfähigkeit des Motors dank der besseren Wärmeableitung
- Fähigkeit hohe Stromstärken auszuhalten dank den nichtmagnetischen Merkmalen

Dank ihren speziellen Merkmalen sind die Motoren GHA CLASSIC für Anwendungen in der LEBENSMITTEL- (ohne Kontakt mit den Lebensmitteln), PHARMA BESONDERS geeignet.

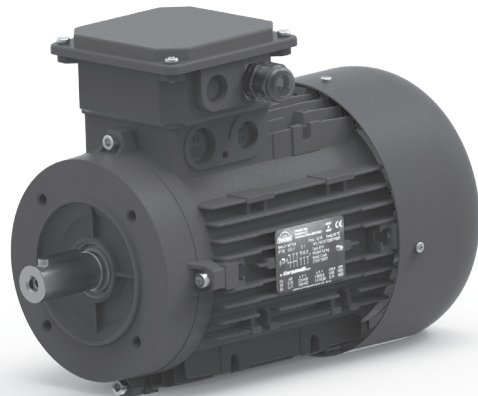
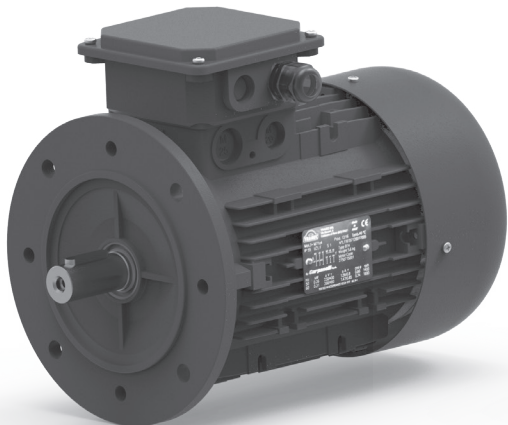

B5

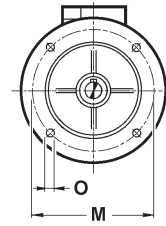
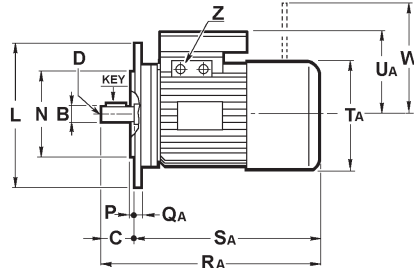
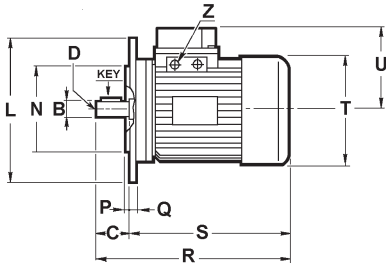

Motori elettrici ⁽¹⁾
Electric motors
Elektromotoren

Motori elettrici autofrenanti ⁽²⁾
Electric brake motors
Elektro-Bremsmotoren

	4 poles	kW	kg. (1)	kg. (2)	B	C	D	L	M	N	O	P	Q	QA	R	RA	S	SA	T	TA	U	UA	W	Z	KEY
56	A	0.06	2.5	4	9	20	M4	120	100	80	7	3	8	8	188	220	167	200	110	110	110	108	90	PG11	3x3x15
	B	0.09	2.6	5																				PG11	3x3x15
	C	0.11	3.2	5																				PG11	3x3x15
63	A	0.13	3.7	5	11	23	M4	140	115	95	9	3	9	9	208	257	193	234	123	123	115	110	98	PG11	4x4x15
	B	0.18	4.3	7																				PG11	
	C	0.22	4.3	7																				PG11	
71	A	0.25	5.8	8	14	30	M5	160	130	110	9	3.5	9	9	245	297	215	267	138	138	124	121	98	PG11	5x5x20
	B	0.37	6.2	8																				PG11	
	C	0.55	7.4	9																				PG11	
80	A	0.55	8.5	11	19	40	M6	200	165	130	11	3.5	10	10	278	336	235	296	156	156	141	138	111	PG16	6x6x30
	B	0.75	9.8	13																				PG16	
	C	0.9	10.5	13.5																				PG16	
90	S	1.1	12	17	24	50	M8	200	165	130	11	3.5	10	10	305	369	250	319	176	176	146	149	129	PG16	8x7x35
	L	1.5	13.5	18											330	394	275	344							
	LB	1.8	15.5	20											PG16										
100	A	2.2	19	25.5	28	60	M10	250	215	180	14	4	14	14	369	434	305	374	194	194	157	160	139	PG16	8x7x45
	B	3	21	28																				PG16	
	BL	4	23	30																				PG16	
112	A	4	29	38	28	60	M10	250	215	180	14	4	14	14	388	467	325	407	220	220	170	172	161	PG16	8x7x45
	BL	5.5	35	44																				PG16	

Le dimensioni dei motori elettrici sono puramente indicative.

The dimensions of the electric motors are approximate values.

Die Abmessungen der Elektromotoren sind Näherungswerte.

B14

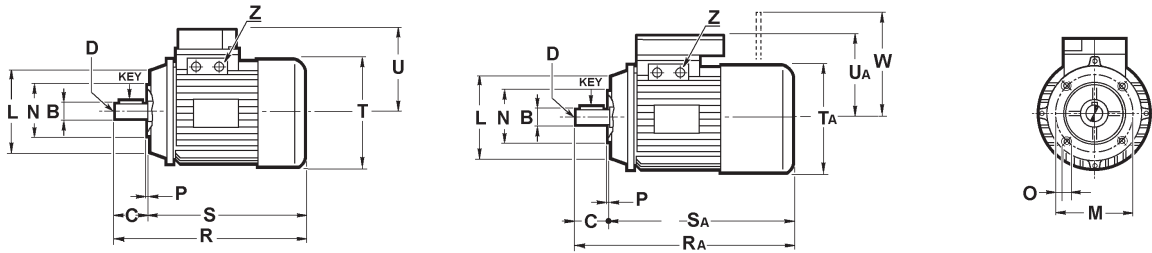

Motori elettrici ⁽¹⁾
Electric motors
Elektromotoren

Motori elettrici autofrenanti ⁽²⁾
Electric brake motors
Elektro-Bremsmotoren

		4 poles		B	C	D	L	M	N	O	P	R	RA	S	SA	T	TA	U	UA	W	Z	KEY	
		kW	kg. (1)																				kg. (2)
56	A	0.06	2.5	4	9	20	M4	80	65	50	M5	2.5	188	220	167	200	110	110	110	108	90	PG11	3x3x15
	B	0.09	2.6	5																		PG11	3x3x15
	C	0.11	3.2	5																		PG11	3x3x15
63	A	0.13	3.7	5	11	23	M4	90	75	60	M5	2.5	208	257	193	234	123	123	115	110	98	PG11	4x4x15
	B	0.18	4.3	7																		PG11	
	C	0.22	4.3	7																		PG11	
71	A	0.25	5.8	8	14	30	M5	105	85	70	M6	2.5	245	297	215	267	138	138	124	121	98	PG11	5x5x20
	B	0.37	6.2	8																		PG11	
	C	0.55	7.4	9																		PG11	
80	A	0.55	8.5	11	19	40	M6	120	100	80	M6	3	278	336	235	296	156	156	141	138	111	PG16	6x6x30
	B	0.75	9.8	13																		PG16	
	C	0.9	10.5	13.5																		PG16	
90	S	1.1	12	17	24	50	M8	140	115	95	M8	3	305	369	250	319	176	176	146	149	129	PG16	8x7x35
	L	1.5	13.5	18									330	394	275	344							
	LB	1.8	15.5	20																			
100	A	2.2	19	25.5	28	60	M10	160	130	110	M8	3.5	369	434	305	374	194	194	157	160	139	PG16	8x7x45
	B	3	21	28																			
	BL	4	23	30																			
112	A	4	29	38	28	60	M10	160	130	110	M8	3.5	388	467	325	407	220	220	170	172	161	PG16	8x7x45
	BL	5.5	35	44																		PG16	8x7x45

Le dimensioni dei motori elettrici sono puramente indicative.

The dimensions of the electric motors are approximate values.

Die Abmessungen der Elektromotoren sind Näherungswerte.

8.0

CONDIZIONI GENERALI DI VENDITA

TERMS AND CONDITIONS OF SALE

8.1	Scopo	<i>Purpose</i>	106
8.1.1	Modifiche alle condizioni generali di vendita	<i>Modification of the conditions of sale</i>	106
8.2	Definizioni generali	<i>General definitions</i>	106
8.3	Riferimenti	<i>References</i>	106
8.4	Offerte e ordinazioni	<i>Offers and orders</i>	106
8.4.1	Offerte	<i>Offers</i>	106
8.4.2	Ordini	<i>Orders</i>	107
8.4.3	Conferma d'ordine	<i>Order confirmation</i>	107
8.5	Prezzo dei prodotti	<i>Price of the products</i>	107
8.6	Spedizione e trasporto	<i>Shipping and transport</i>	108
8.7	Termini di consegna	<i>Terms of delivery</i>	108
8.8	Pagamenti	<i>Payments</i>	108
8.8.1	Reclami e/o contestazioni	<i>Claims and / or disputes</i>	108
8.8.2	Non conformità	<i>Non-compliance</i>	109
8.8.3	Restituzione del materiale	<i>Return of material</i>	109
8.8.4	Garanzia dei prodotti	<i>Product warranty</i>	109
8.9	Marchi e diritti di proprietà intellettuale	<i>Trademarks and intellectual property rights</i>	109
8.10	Controversie e risoluzione contrattuale	<i>Disputes and contract termination</i>	110
8.10.1	Clausola risolutiva art. 1755 C.C.	<i>Termination art. 1755 C.C. (Italian Civil Code)</i>	110
8.10.2	Clausola risolutiva art. 1761 C.C.	<i>Termination art. 1761 C.C. (Italian Civil Code)</i>	110

8.1 Scopo

Le presenti "Condizioni Generali di Vendita" (di seguito denominate "Condizioni di Vendita"), si applicano e regolano tutte le forniture di prodotti con marchio "TRAMEC" e/o commercializzate dalla stessa, e annullano qualsiasi clausola o termine pattuito dal Cliente, sia nella singola vendita che in documentazioni di provenienza dello stesso, che non sia stata accettata da un preventivo consenso scritto da parte di "TRAMEC Srl".

8.1.1 Modifiche alle condizioni di vendita

"TRAMEC Srl" si riserva il diritto di modificare, aggiungere, cancellare qualsiasi punto delle presenti Condizioni di Vendita, che si riterranno applicate a tutti gli ordini successivi alla data di notifica al Cliente delle nuove Condizioni di Vendita.

8.2 Definizioni generali

Per una maggiore chiarezza nella lettura delle presenti Condizioni di Vendita, si definiscono i seguenti termini:

- "TRAMEC" : TRAMEC Srl, Via Bizzarri,6 – 70012 Caldera di Reno (BO) - ITALY
- "Prodotti": Tutti i beni prodotti, assemblati, commercializzati e/o venduti da TRAMEC Srl
- "Cliente" : Tutte le società legalmente costituite e/o entità giuridiche che acquistano beni, prodotti o servizi da TRAMEC Srl
- "Ordine" : Ogni proposta di acquisto di beni, prodotti o servizi inoltrata da un cliente a TRAMEC Srl e confermata per accettazione con "Conferma d'ordine" dalla stessa.
- "Marchi" : Tutti i marchi di proprietà di TRAMEC Srl di cui è proprietaria e/o licenziataria
- "Brevetti e Proprietà Intellettuale" : Qualsiasi diritto legato alla protezione del proprio Know-How, coperto da brevetti italiani e internazionali, per invenzioni, marchi, modelli, disegni e prodotti di cui TRAMEC Srl ne detiene ed è proprietaria dei diritti, siano essi registrati ,che in fase di registrazione compresi qualsiasi altra forma prevista dalla leggi internazionali.

8.3 Riferimenti

Il presente documento è parte integrante del "LISTINO PREZZI TRAMEC", di cui copia è pubblicata sul sito aziendale www.tramec.it

8.4 Offerte e ordinazioni

8.4.1 Offerte

Su richiesta del Cliente, TRAMEC direttamente o attraverso la propria rete vendita, formulerà una proposta di acquisto per i propri prodotti indicati dal Cliente, formalizzandola per iscritto. L'offerta di vendita/proposta di acquisto non è da ritenersi impegnativa da parte del Cliente, e avrà validità 30(trenta) giorni. Allo scadere di tale termine, TRAMEC si riterrà svincolata da impegni e su richiesta del cliente riformulerà una nuova offerta/proposta. Data la natura riservata del contenuto dell'offerta/proposta ricevuta il Cliente, si impegna a non divulgarne il contenuto.

8.1 Purpose

The present "General Conditions of Sale" (hereinafter referred to as "Conditions of Sale"), shall apply and shall govern all supplies of "TRAMEC" products with "TRAMEC" label and / or directly commercialized by "TRAMEC" , and cancel any clause or term agreed upon by the Customer which have not been accepted by prior consent in writing by "TRAMEC Srl".

8.1.1 Modification of the conditions of sale

"TRAMEC SRL" reserves the right to modify, add, delete any part of these "Conditions of Sale", which will be deemed to apply to all orders received after the date of Customer's notification.

8.2 General definitions

For a better understanding of these Conditions of Sale, we define the following terms:

- "TRAMEC" : TRAMEC Srl, Via Bizzarri,6 – 70012 Caldera di Reno (BO) - ITALY
- "Products": All goods manufactured, assembled, commercialized and / or sold by TRAMEC Srl.
- "Customers" : All companies legally established and / or legal entities buying goods, products or services from TRAMEC SRL
- "Orders" : Each offer to purchase goods, products or services sent by the Customer to TRAMEC Srl and confirmed for acceptance with an "order confirmation" directly from TRAMEC Srl
- "Trademarks" : All trademarks owned or of which TRAMEC Srl is licensee.
- " Patents and Intellectual Property" : all rights related to the protection of their own Know - How, covered with Italian and international patents for inventions, trademarks, models, designs and products for which TRAMEC SRL holds and owns the rights, whether registered or under registration, including any other form prescribed by the International laws.

8.3 References

This document is an integral part of the "PRICE LIST of TRAMEC", a copy of which is posted on the company website www.tramec.it

8.4 Offers and orders

8.4.1 Offers

On customer request, TRAMEC directly or through its own sales network, will submit a written proposal for the products required by the Customer. The offer shall not be binding for the Customer and will have a 30 (thirty) days validity. After this period the offer is void and upon Customer request TRAMEC will submit a new proposal. TRAMEC written offers are intended for the receipt and viewing of the Customer, and disclosure of the offer with competitors could render the offer null and void.

8.4.2 Ordini

Tutti gli ordini di acquisto dei prodotti TRAMEC, devono essere formalizzati per iscritto dal Cliente su propria carta intestata ed inviati tramite mail, fax o lettera direttamente ai riferimenti indicati nell'offerta/proposta ricevuta, avendo cura di aver indicato:

- Riferimento a n. offerta,
- codice prodotto,
- descrizione prodotto,
- quantità richiesta,
- prezzi e termini di consegna.

TRAMEC ha previsto la possibilità di accettare anche ordini a carattere di "URGENZA" **previ accordi telefonici con il commerciale TRAMEC di riferimento**, che devono essere formalizzati per iscritto dal Cliente, e che prevedono una consegna entro 5 (cinque) oppure 6-9 (da sei a nove) gg lavorativi dalla data di accettazione dell'ordine stesso. A tali ordini verrà applicato una maggiorazione del **15% (quindicipercento)** e del **7% (settepercento)** rispettivamente, calcolata sul totale lordo EX WORKS dell'ordine, in aggiunta agli importi netti totali.

ATTENZIONE!!

Tutti gli ordini a carattere d'urgenza, una volta accettati e confermati da TRAMEC, non saranno più modificabili né cancellabili.

8.4.3 Conferma d'ordine

La vendita si riterrà conclusa con l'invio della Conferma d'Ordine che TRAMEC inoltrerà al Cliente. Tale Conferma d'Ordine sarà inoltrata al cliente tramite mail o su richiesta tramite fax direttamente ai riferimenti indicati dal Cliente. La Conferma d'Ordine sarà conforme, all'ordine di acquisto del Cliente ricevuto da TRAMEC, sia nei termini che nelle condizioni indicate e concordate. Trascorsi 2 (due) giorni lavorativi dall'invio della Conferma d'Ordine, TRAMEC riterrà confermato l'ordine da parte del Cliente ed ogni inesattezza eventualmente contenuta e non contestata in forma scritta da parte del Cliente e confermata sempre in forma scritta da TRAMEC (con nuova Conferma d'Ordine revisionata), evidenziata alla consegna dei prodotti al Cliente non sarà più contestabile o annullabile.

8.5 Prezzo dei prodotti

Tutti i prezzi dei prodotti indicati negli ordini di vendita, e nelle relative offerte, fanno riferimento al listino prezzi TRAMEC, in vigore al momento del loro inoltro al Cliente. Qualora non fosse presente il prodotto in ordine nel listino prezzi TRAMEC, avrà valore quanto concordato e confermato per iscritto nell'ordine stesso.

Eccetto quanto concordato per iscritto tra le parti, i prezzi indicati nell'ordine di vendita TRAMEC sono calcolati franco fabbrica,

al netto dell'IVA e degli sconti. Tali prezzi inoltre non includono eventuali costi di imballaggio, spedizione e trasporto dai locali di TRAMEC ai locali del cliente, che saranno sostenuti separatamente dal Cliente.

TRAMEC manterrà la proprietà dei Prodotti venduti al Cliente fino alla completa corresponsione del prezzo degli stessi. La presente clausola di riserva di proprietà, obbliga il Cliente a compiere tutti gli adempimenti previsti per legge, ove previsto, per rendere valida ed eseguibile nei confronti di tutti i terzi tale vincolo.

TRAMEC si riserva il diritto di modificare unilateralmente e senza preavviso, con effetto immediato i prezzi riportati nel proprio listino, nei casi in cui l'adeguamento sia dovuto a cambiamenti impreveduti di condizioni di mercato delle materie prime o dei tassi di cambio. Ogni modifica verrà comunque comunicata al Cliente ed applicata al successivo ordine ricevuto.

8.4.2 Orders

All purchase orders of TRAMEC products must be formalized in writing by the customer, on his own letterhead and sent via mail, fax or letter directly to the references mentioned in the offer, making sure to add :

- Offer reference number ,
- Product Code,
- Product Description,
- Required Quantity,
- Prices and Terms of Delivery.

An "URGENT" production option may be agreed case by case with the sales department of TRAMEC. To accept the urgent production option , Customer must state in writing, requesting URGENT option, and consider standard shipment of urgent orders to be either 5 (five) or 6-9 (from six to nine) working days from the date of TRAMEC's acceptance of order, depending on availability at order time. Such urgent orders will be charged an additional 15% (fifteen percent) or 7% (seven percent) respectively, calculated on the total EX WORKS value of the order.

ATTENTION!!!!

Urgent orders, once acknowledged by TRAMEC, are non-cancelable and may not be modified.

8.4.3 Order confirmation

TRAMEC will acknowledge the Customers Order via e mail or on request by fax to the address specified by the Customer. All Orders to be performed are subject to the Terms and Conditions Agreed to between the parties.

The Customer will have two (2) days to review the acknowledgment for errors or inaccuracies to notify TRAMEC for correction, after these two (2) days the Order will be considered acknowledged by the Customer and can no longer be contested or canceled.

8.5 Price of the products

All prices listed on the sales orders, and on offers, refer to the Price List of "TRAMEC" valid at time of their transmission to the Customer.

If the product is not mentioned on the Price List of "TRAMEC", its value will be the one agreed to between the parties in writing.

Unless differently agreed, the prices indicated on the sales order of TRAMEC will be calculated on ex-works basis, VAT and Discounts excluded.

These prices do not include any costs for packaging, shipping and transport from TRAMEC warehouse to the Customer premises, which will be paid separately by the Customer.

TRAMEC will retain the ownership of the Products sold to the customer until their complete payment. Because of this saving clause of ownership, the Customer is due to carry out all formalities required by law, and if necessary, to make such a constraint valid and enforceable against all third.

TRAMEC reserves the right to modify the prices of the price list, unilaterally and without notice, with immediate effect , if the adjustment is due to unexpected changes in market conditions, in raw materials or in exchange rates. Each modification will however be noted and indicated on the Order Acknowledgement and will apply to the next order.

8.6 Spedizione e trasporto

La spedizione viene effettuata tramite vettori nazionali ed internazionali, indicati dal Cliente o in mancanza di indicazioni scelti in autonomia da TRAMEC. La scelta del vettore viene effettuata sulla base di valutazione di convenienza e di garanzia del trasporto che il vettore stesso assicura/certifica. Tutto il materiale viaggia a spese e rischio del Cliente stesso, e si intende accettato dal Cliente all'atto di inizio del trasporto da parte del vettore. Eventuali danni occorsi al materiale durante il trasporto, non sono coperti da garanzia TRAMEC. Come indicato al punto 8.5 PREZZO DEI PRODOTTI, la merce viaggia sempre FRANCO FABBRICA.

8.7 Termini di consegna

I termini di consegna indicati nella Conferma d'Ordine, hanno carattere puramente indicativo e sono da ritenersi fissati salvi imprevisti ascrivibili a circostanze di forza maggiore e che siano fuori dal proprio controllo. A titolo esemplificativo e senza pretesa di esaustività si elenca quanto segue:

- a) Ritardi da parte del cliente a fornire dati tecnici o amministrativi necessari alla spedizione dei prodotti
- b) Difficoltà da parte di TRAMEC nell'acquisizione di materie prime necessarie alla produzione dei prodotti
- c) Scioperi parziali o totali, calamità naturali, difficoltà nel trasporto dei materiali, etc. e tutte le altre cause di forza maggiore
- d) Ritardi dovuti a terzi o allo spedizioniere

Il verificarsi di alcuni degli eventi elencati o di altra natura non elencati, non darà diritto al Cliente di esigere indennizzi di sorta o richiesta di risarcimento danni.

8.8 Pagamenti

TRAMEC a propria discrezione emetterà fattura, salvo accordi scritti tra le parti, all'atto della spedizione dei prodotti o in anticipo all'atto dell'accettazione dell'ordine del Cliente. Tutti i pagamenti sono previsti in EURO, eccetto per accordi commerciali che prevedano altra valuta. I pagamenti devono essere effettuati entro i termini stabiliti indicati nella Conferma d'Ordine, anche in presenza di reclami o contestazioni.

Ogni ritardo o mancato pagamento rispetto ai termini stabiliti darà diritto a TRAMEC di sospendere qualsiasi consegna di prodotti e/o ordine in corso e richiedere al Cliente il pagamento degli interessi bancari così come previsto dalle leggi vigenti nella misura del tasso stabilito da BCE + 7% (Settepercento).

Ogni reclamo e/o contestazione non potrà comunque in nessun modo giustificare la sospensione o il ritardato pagamento.

8.8.1 Reclami e/o contestazioni

Ogni tipologia di reclamo o contestazione dovrà essere formalizzato/a a TRAMEC in forma scritta direttamente all'indirizzo email customer.care@tramec.it o attraverso la sezione "Customer Care" presente sul proprio sito www.tramec.it. Eventuali reclami riferiti a vizi o difetti dei prodotti ricevuti dovranno essere segnalati a TRAMEC, sempre in forma scritta, entro 10 (dieci) gg dalla data di consegna.

Nel caso che tali vizi o difetti si evidenziassero, per la loro natura, successivamente alla data di consegna, essi dovranno essere segnalati, sempre in forma scritta, a TRAMEC immediatamente entro e non oltre 5 (cinque) gg dalla data di rilevazione, e comunque saranno ritenuti tali entro e non oltre l'anno di garanzia previsto per i prodotti TRAMEC.

Le spese di trasporto sono a carico del Cliente salvo diverso accordo tra le parti.

8.6 Shipping and transport

Shipments will be handled by national and international carriers specified by the Customer, if specific instructions are not included they will be at TRAMEC's discretion. Where shipment is made at TRAMEC's discretion, carrier choice will be made based on convenience and delivery terms assured by the carriers. Goods are sold to Customer and considered EX-WORKS (see 8.5.PRICE OF THE PRODUCTS), all transportation expense, loss, damages, or delays to be the risk and responsibility of the Customer and their carrier, and not subject to TRAMEC warranty written or implied.

8.7 Terms of delivery

Delivery terms mentioned in "TRAMEC" Order Confirmation are considered agreed upon and to be honored bearing unexpected events outside "TRAMEC" control, in example:

- a) The Customers delay of technical or administrative information necessary for the timely dispatch of the products.*
- b) Difficulties in the acquisition of raw materials required to manufacture TRAMEC products.*
- c) Total or partial labor strikes, natural disasters, transportation difficulties or other circumstances beyond TRAMEC control.*
- d) Delays due to third parties or to be inbound shipping company*

The occurrence of some of the events listed or other not listed, do not entitle the customer to claim any compensation or claim for damages.

8.8 Payments

Unless stated in writing and agreed upon, "TRAMEC" will invoice the Customer on Confirmation of Order for Customers with Prepaid Terms, or at time of shipment for the Customers with NET trade credit terms. Payments are to be made in EURO, except where specific commercial agreements are made in alternative currencies. Payments must be made within the stated NET terms offered at time of Order Confirmation, regardless of outside claims or conflicts.

Delay or missing payments outside of the agreed terms will afford TRAMEC the right to suspend any delivery of products, services, and any pending orders, as well as require the Customer to pay interest on past due invoices, as provided by law, to the extent determined by the ECB rate + 7% (seven percent)

NO claim or dispute can justify the suspension, delay, or non-payment of invoices due.

8.8.1 Claims and / or disputes

Each complaint or claim must be transmitted in writing to "TRAMEC", directly to the e mail address customer.care@tramec.it or through the website www.tramec.it, "Customer Care" section.

Any claim relating to defect must be reported in writing to "TRAMEC" within 10 (ten) days of the receipt of the product.

If a defect is noticed or occurs after the delivery date, it must be reported in writing to TRAMEC within 5 (five) days of the date the defect was detected, and always within the 1 (one) year warranty provided for TRAMEC products.

Transportation costs are borne by the Customer unless otherwise agreed to by TRAMEC and the Customer.

8.8.2 Non conformità

Eventuali non corrispondenze in tipologia del prodotto e/o quantità, rispetto a quanto indicato in Conferma d'Ordine, dovrà essere prontamente segnalata in forma scritta a TRAMEC o al proprio agente di riferimento entro e non oltre 5(cinque) gg dalla data di consegna del materiale. Dopo tale scadenza i prodotti consegnati si riterranno conformi all'ordine del Cliente e non potranno essere più contestati a TRAMEC. Le spese di trasporto sono a carico del Cliente salvo diverso accordo tra le parti.

8.8.3 Restituzione del materiale

Il materiale non può essere restituito a TRAMEC, senza preventiva autorizzazione scritta da parte della stessa. Eventuali materiali ricevuti senza che il Cliente abbia effettuato una segnalazione scritta così come previsto ai punti 8.8.1 e 8.8.2, ed autorizzata da TRAMEC, verranno respinti al mittente, con addebito delle spese di trasporto salvo diverso accordo tra le parti.

8.8.4 Garanzia dei prodotti

TRAMEC garantisce i propri prodotti, così come previsto dalle leggi vigenti, per un periodo di 1(uno) anno dalla data di fatturazione degli stessi. La garanzia opererà su tutti i prodotti TRAMEC, ove saranno rilevabili difetti di costruzione, montaggio o progettazione e comporterà per TRAMEC l'onere della sostituzione o riparazione delle parti difettose senza nessun altro aggravio e/o addebiti per danni diretti e/o indiretti di qualsiasi natura.

La garanzia decade nel caso siano state eseguite riparazioni, modifiche o manomissioni senza autorizzazione scritta da parte di TRAMEC e nel caso di mancanza della targhetta originale di fabbrica, presente su tutti i prodotti TRAMEC.

Un uso negligente o improprio e inosservanza delle prescrizioni sull'uso, manutenzione e conservazione dei prodotti, comporterà la decadenza immediata della garanzia. Il prodotto, coperto da garanzia, dovrà essere restituito a TRAMEC, così come indicato al punto 8.8.3, con spese di trasporto a carico del Cliente salvo diverso accordo tra le parti. La proprietà del prodotto o componente sostituito in garanzia, ove risultasse difettoso, sarà trasferita a TRAMEC dal Cliente.

Ogni diritto di garanzia non sarà applicabile, su quei prodotti a cui ancora non siano stati completamente corrisposti, alle condizioni e termini pattuiti, i relativi importi dovuti così come da fattura di riferimento. TRAMEC inoltre non garantisce nessuna garanzia circa alle conformità dei prodotti a norme e regolamenti di Paesi o Stati che non rientrano e appartengano alla Comunità Europea.

8.9 Marchi e diritti di proprietà intellettuale

TRAMEC è l'unica titolare dei propri Marchi, ed il Cliente si asterrà dall'utilizzo degli stessi senza preventiva autorizzazione, o registrare Marchi simili e/o confondibili con i medesimi. Ogni loro utilizzo comunque dovrà essere autorizzato in forma scritta da TRAMEC sia nelle modalità che nella forma, secondo indicazioni concordate con il titolare dei Marchi.

Tutti i diritti di Proprietà Intellettuale sono di totale ed esclusiva proprietà di TRAMEC e la loro comunicazione o utilizzo nell'ambito delle presenti "Condizioni Generali di Vendita" non produce nessun diritto o pretesa in capo al Cliente, che si obbliga a non compiere atti o richieste a contestarne la Titolarità e Proprietà.

8.8.2 Non-compliance

Any non-compliance with either product or its quantity found to be different from what is stated on Order Confirmation, must be reported in writing to TRAMEC or its Agent, no later than 5 (five) days from the delivery date of the material.

With no notification made after this time, the products will be considered complying with the order acknowledged to the Customer and shall no longer be contested to TRAMEC. Transportation costs are borne by the Customer unless otherwise agreed to by TRAMEC and the Customer.

8.8.3 Return of material

No goods or materials can be returned without "TRAMEC" prior written authorization. Materials received without authorization and written report from the Customer, as required in point 8.8.1 & 8.8.2, and fully authorized by "TRAMEC", will be returned to the sender at the senders expense for all transportation and customs fees, unless otherwise agreed to between the parties in writing.

8.8.4 Product warranty

"TRAMEC" guarantees its products, as provided by law, for a period of 1 (one) year from the date of invoice. This guarantee will be valid for all "TRAMEC" products, where construction, installation or design defects will be detected and will lead to "TRAMEC" the burden of replacement or repair of defective parts at its discretion without any other burden or responsibility or charges for any direct and / or indirect damages or expense.

"TRAMEC" warranty is void if repairs, changes or alterations are carried out on the product without the written consent of "TRAMEC", and only valid with the original nameplate which is found on all "TRAMEC" products.

The negligent or improper use as well as failure to observe regulations governing the utilization, maintenance and storage of products, will result in the immediate loss of this guarantee. The product, covered by the warranty, will have to be returned to "TRAMEC" free of charge, as indicated in point 8.8.3, with all transportation costs borne by the Customer unless otherwise agreed between the parties in writing. The product or component replaced under warranty, if it is defective, will belong to "TRAMEC".

The warranty will not be valid for products that are not paid in full, according to the conditions and terms agreed, and for the amounts due per relevant invoice.

"TRAMEC" provides no guarantee as for the conformity of their products with the standards and regulations of Countries or States not belonging to the European Community.

8.9 Trademarks and intellectual property rights

TRAMEC is the sole owner of its brands, and the Customer will refrain from the use of them without prior authorization, or register similar ones and/or brands that are easily confused with TRAMEC's brands. Every use of TRAMEC brands requires the authorization in writing by TRAMEC, both in terms and form, according to instructions agreed with the owner of these trademarks.

All Intellectual Property Rights are the complete and exclusive property of TRAMEC and their communication or use under these "Terms of Sale" does not product any right or claim to the Customer, which is obliged to refrain from acts or request to question the Possessory title and Property.

8.10 Controversie e risoluzione contrattuale

Tutte le controversie derivanti da o connesse alle presenti Condizioni di Vendita e/o ad ogni vendita, sono assoggettabili alla esclusiva giurisdizione del Foro competente di Bologna (ITALIA).

TRAMEC Srl è legalmente domiciliata presso la sua sede principale di Via Bizzarri,6 – 70012 Calderara di Reno(BO) – ITALY.

8.10.1 Clausola risolutiva art. 1755 C.C.

TRAMEC avrà facoltà di risolvere, ai sensi e per gli effetti dell'art. 1755 del Codice Civile Italiano, in qualsiasi momento con comunicazione scritta al Cliente, la singola vendita nel caso di inadempimento delle obbligazioni così come previsto ai punti 8.5 (Prezzo dei Prodotti), 8.8 (Pagamenti), 8.9 (Marchi e Diritti di Proprietà Intellettuale).

8.10.2 Clausola risolutiva art. 1761 C.C.

TRAMEC avrà diritto di sospendere, ai sensi e per gli effetti dell'art. 1761 del Codice Civile Italiano, in qualsiasi momento con comunicazione scritta al Cliente, tutte le obbligazioni in corso derivanti dalla vendita dei prodotti, nel caso in cui le condizioni patrimoniali del Cliente divenissero e/o risultassero tali da porre in serio dubbio la naturale acquisizione della contropartita prevista.

TRAMEC potrà valutare eventuali garanzie accessorie proposte dal Cliente, come assicurazione sulle obbligazioni in essere.

8.10 Disputes and contract termination

All disputes due or related to these "Terms of Sale" and / or any sale, are subject to the exclusive jurisdiction of the Competent Court of Bologna (ITALY).

TRAMEC SRL is legally domiciled at its headquarters in Via Bizzarri, 6-70012 Calderara di Reno (BO) - ITALY.

8.10.1 Termination art. 1755 C.C. (Italian Civil Code)

"TRAMEC" may terminate, pursuant to art. 1755 of the Italian Civil Code, at any time by written notice to the Customer, the single sale in the event of breach of the obligations as set out in paragraphs 8.5 (Product Price), 8.8 (Payments), 8.9 (Trademarks and Intellectual Property Rights) .

8.10.2 Termination art. 1761 C.C. (Italian Civil Code)

"TRAMEC" will be entitled to suspend, pursuant to art. 1761 of the Italian Civil Code, at any time by written notice to the Customer, all current obligations arising from the sale of the products, in the event that the financial conditions of the Customer would become and/or result to call into serious doubt the natural acquisition of expected offset.

"TRAMEC" may consider any additional guarantees proposed by the Customer, such as insurance on outstanding obligations.

09/2019

Questo catalogo annulla e sostituisce ogni precedente edizione o revisione.
Tutti i dati elencati sono indicativi e s'intendono senza impegno alcuno da parte nostra.
Ci riserviamo il diritto di apportare modifiche senza preavviso.

*This catalogue cancels and replaces any previous edition and revision.
All listed data are approximate and it's understood that this entails no obligation on our part.
We reserve the right to implement modifications without notice.*

Mit der Ausgabe dieses Katalogs annullieren sich gleichzeitig alle bisherigen Katalogen.
Sämtliche Daten sind Berechnete Werte die für den Verkäufer unverbindlich sind.
Der Verkäufer behält sich das Recht vor, Änderungen, ohne eine vorhergehende Advisierung durchzuführen.



Stai per acquistare il primo riduttore al mondo antibatterico e batteriostatico, **brevettato** da "TRAMEC srl".
Il riduttore "GHA" nasce dall'inventiva italiana ed è totalmente "Made in Italy".

Scopri di più sul sito www.ghapremium.com

Sie sind im Begriff, das weltweit erste, antibakterielle und bakteriostatische Getriebe von "TRAMEC srl" zu kaufen.
Das "GHA" - Getriebe ist eine italienische Erfindung, komplett "Made in Italy" und von "TRAMEC srl" patentiert.

Weitere Informationen finden Sie unter www.ghapremium.com

You are about to buy the first antibacterial and bacteriostatic gearbox in the world, patented by "TRAMEC srl".
The "GHA" gearbox comes from Italian inventiveness and is totally "Made in Italy".

Find out more information on www.ghapremium.com



Antibattericità
Antibacterial properties
Antibakterielle eigenschaften



Resistenza alla corrosione
Corrosion resistance
Korrosionsbeständigkeit



Elevata conducibilità termica
High thermal conductivity
Hohe wärmeleitfähigkeit



Elevata durezza della superficie
High surface hardness
Hohe oberflächenhärte